



GM9907-LD

User's Manual

110608030006

V03.01.08

©2020, Shenzhen General Measure Technology Co., Ltd. All rights reserved.

Without Shenzhen General Measure Technology Co., Ltd.'s permission, any company or person have no responsibility to copy, transmit, transcribe or translate to any language version.

Our company's products are under continually improvement and updating so we reserved the right to modify this manual at any time without notice. For this reason, please visit our website regularly to update newest information.

Company Website [http:// www.gmweighing.com](http://www.gmweighing.com)

Product Performance Standards: GB / T 7724-2008



Contents

1.	Outline	- 1 -
	1.1 Functions and Features	- 1 -
	1.2 Front Panel Description	- 2 -
	1.3 Rear Panel Description	- 3 -
	1.4 Technical Specifications	- 4 -
	1.4.1 General specifications	- 4 -
	1.4.2 Analog part	- 4 -
	1.4.3 Digital part	- 4 -
2.	Installation	- 5 -
	2.1 General principle	- 5 -
	2.2 Load Cell Connection	- 5 -
	2.3 I/O Module Port Connection	- 5 -
	2.4 Power Supply Connection	- 6 -
	2.5 Serial Port Connection	- 6 -
	2.6 Touch Screen Calibration	- 7 -
3.	User Permission Description	- 9 -
4.	Menu	- 9 -
	4.1 Calibration	- 11 -
	4.2 Recipe Parameter	- 12 -
	4.3 Weighing Parameter	- 17 -
	4.4 Maintenance	- 18 -
	4.4.1 Scale Structure	- 19 -
	4.4.2 Peripheral ON/OFF	- 22 -
	Peripheral ON/OFF	- 22 -
	4.4.3 Communication Setting	- 23 -
	4.4.4 Auxiliary Logic Function	- 24 -
	4.4.5 Factory Reset	- 28 -
	4.4.6 Hardware Test	- 29 -
	4.4.7 Display Style	- 30 -
	4.5 Peripheral Parameter	- 30 -
	4.6 Motor Parameter	- 35 -
	4.7 ACUM	- 42 -
	4.8 I/O Module	- 42 -
	4.8.1 Output port & input port definition	- 44 -
	4.9 Host mode	- 56 -
5.	Function Description	- 57 -
	5.1 Setting the operating mode	- 57 -
	5.2 Batch	- 58 -
	5.3 Filling Level Control	- 58 -
	5.3.1 Dual Supplement	- 58 -
	5.3.2 Single Supplement	- 58 -
	5.4 Quick Setup	- 59 -
	5.5 U disk update software	- 59 -
	5.5.1 Foreground update process	- 59 -
	5.5.2 Background update process	- 59 -
	5.6 U disk update boot interface	- 59 -

5.7 Sewing control	- 60 -
5.8 Discharge patting control	- 60 -
5.9 Alarm function of filling and discharge overtime	- 61 -
5.10 Auxiliary pulse function	- 61 -
5.11 Adaptive function	- 61 -
5.12 Hanger up control function	- 62 -
6. Serial port communication	- 63 -
6.1 Printing method	- 63 -
6.1.1 Auto Print	- 63 -
6.1.2 Total cumulative print	- 64 -
6.1.3 Cumulative print the recipe	- 66 -
6.1.4 User cumulative print	- 66 -
6.2 Continuous mode	- 67 -
6.2.1 Continuous mode data frame format is as follows:	- 67 -
6.3 Modbus-RTU protocol	- 67 -
6.3.1 Function code and abnormal code	- 67 -
6.3.2 MODBUS transmission mode	- 68 -
6.3.3 MODBUS address assignment	- 68 -
6.4 Re-ContA/B protocol	- 97 -
7. Auto packaging process	- 99 -
7.1 Dual scale Net Weigher mode packaging	- 99 -
7.2 Scale A Net Weigher mode packing	- 101 -
7.3 Scale B Net Weigher mode packing	- 102 -
7.4 Dual hopper dual clampe bag AB separate packing mode	- 103 -
7.5 Dual hopper dual clip bag AB Comb packing mode	- 104 -
7.6 Dual scale Gross Weigher mode packing	- 106 -
7.7 Dual scale Gross Weigher individual packing	- 106 -
7.8 Bulk accumulation process	- 108 -
8. Motor Work Process	- 110 -
8.1 Motor Filling Portion	- 110 -
8.1.1 Step Motor Drive Filling	- 110 -
8.1.2 Motor Drive Filling	- 110 -
8.2 Motor lock Bag Portion	- 111 -
8.2.1 Step Motor Drive lock/unlock bag	- 111 -
8.2.2 Motor Drive Dual-Limit lock/unlock bag	- 112 -
8.2.3 Motor Drive Single-Limit lock/unlock bag	- 112 -
8.3 Motor Discharge Portion	- 113 -
8.3.1 Step Motor Drive Discharge	- 113 -
8.3.2 Motor Drive Single-Limit Discharge	- 113 -
8.3.3 Motor Drive Dual-Limit Discharge	- 114 -
8.3.4 Motor Drive Rotating Discharge	- 114 -
8.4 Motor Debug Function	- 115 -
9. Dimension (mm)	- 116 -

1. Outline

GM9907 bagging controller is a new weighing controller specially developed for automatic quantitative packing scale with double scale increment method. The controller adopts the English touch screen display interface, the operation is intuitive and simple; The new algorithm makes the weighing control faster and more accurate. USB interface and dual serial port make the device easier to system interconnection. Can be widely used in feed, chemical, food and other industries that need quantitative packaging equipment.

1.1 Functions and Features

- Full English display interface, make the operation more intuitive and easy
- Three optional weigher mode: Net Weigher mode , Gross Weigher mode and bulk scale.
- 28 ON/OFF input and output control (12 in /16 out); input and output port location can be customized.
- ON/OFF test functions, and convenient packaging weighers debugging
- Three levels speed automatic control filling, with optional slow jogging.
- It can store 40 kinds of recipes for different range of materials
- Convenient USB port to input and output of various types parameters
- fill control functions, convenient packing scale with the front filling device of control Multiple digital filter function
- Automatic drop correction function
- Multiple digital filtering function
- Batch number setting function
- Patting bag function for packing powder materials
- Automatic zero tracking function
- Time / date function
- User permission identity settings
- Dual serial ports to connect with printer, computer, Secondary display.

1.2 Front Panel Description

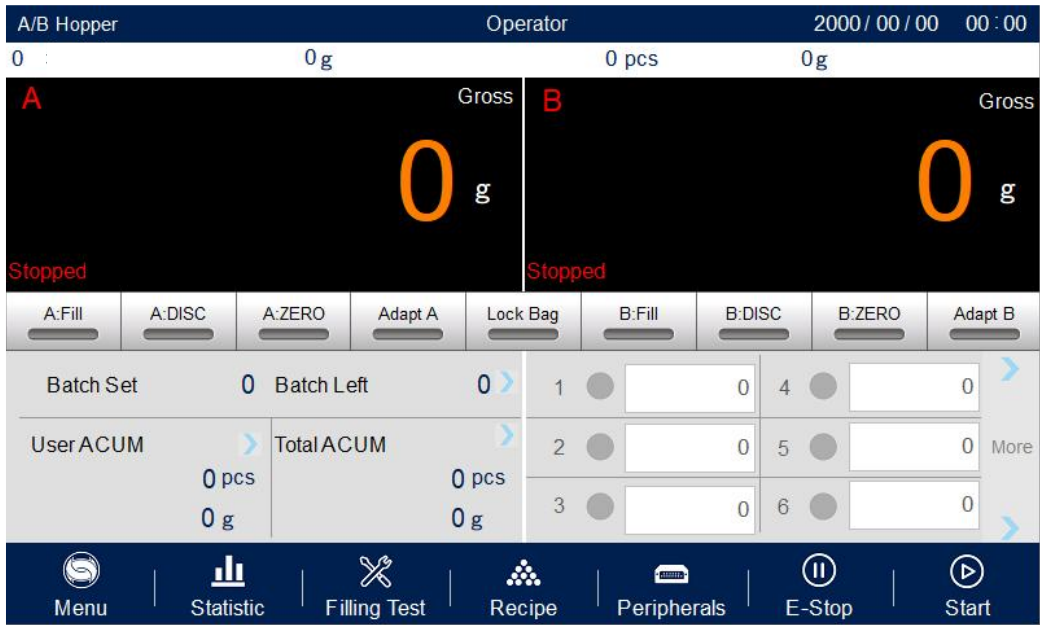

Interface Description:

- ① User info: Show user ID, recipe ID, system time, total ACUM and batch.
- ② Weight status: Weight value display, weight unit display, 9 digit display and output I/O module shortcut.
- ③ Shortcut: Fill, DISC, ZERO, Adapt shortcuts for scale A and scale B.
- ④ Packaging info: show current ACUM info, shortcut setting, batch and target value.
- ⑤ Function parameters: Controller menu parameter and setting.



Debug interface description:

- ① Shortcut setting recipe parameter: Can promptly setting recipe parameter, debug controller easliy.
- ② Packing history record: Can view the current packaging history data directly, easy to compare.

Indicator light Description :

Right one: power light;

1.3 Rear Panel Description

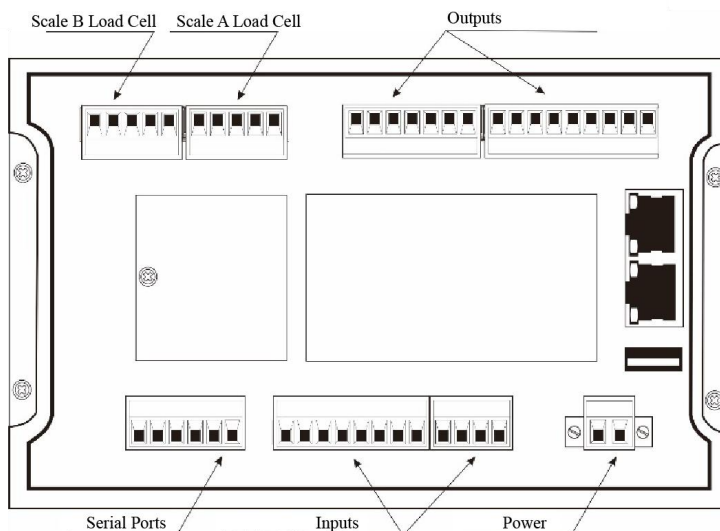

1.4 Technical Specifications

1.4.1 General specifications

Power supply: **DC24V**
 Power filter: Included
 Operating temperature: **-10 ~ 40 °C**
 Maximum humidity: 90% RH without dew
 Power consumption: about **15W**
 Dimensions: **190mm × 124mm × 48mm**

1.4.2 Analog part

Load cell power supply: **DC5V 125mA (MAX)**
 Input impedance: **10MΩ**
 Zero adjustment range: **0.002 ~ 15mV (when load cell is 3mV/V)**
 Input sensitivity: **0.02uV/d**
 Input range: **0.02 ~ 15mV**
 Conversion: **Sigma-Delta**
 A/D Conversion rate: **120、240、480、960 Times/second**
 Non-linear: **0.01% F.S**
 Gain drift: **10PPM/°C**
 The maximum display accuracy: **1/100000**

1.4.3 Digital part

Display: **7 inch** resistance touch screen
 Negative display: "—"

Overload Indication: weight over range/low signal of load cell
 Decimal point position: 5 options

2. Installation

2.1 General principle

- 1) Make appropriate installation holes on the control box, (size: $179 (\pm 1) \text{ mm} \times 113 (\pm 1) \text{ mm}$)
- 2) Install the GM9907-LD into a control box.
- 3) Remove the fixing plates on both sides of GM9907-LD, fix it with the fixing plates and lock them with M3*10 screws.

2.2 Load Cell Connection

When you chose the six-wired load cells, you must bridge the SN+ with EX+ and bridge the SN- with EX-.

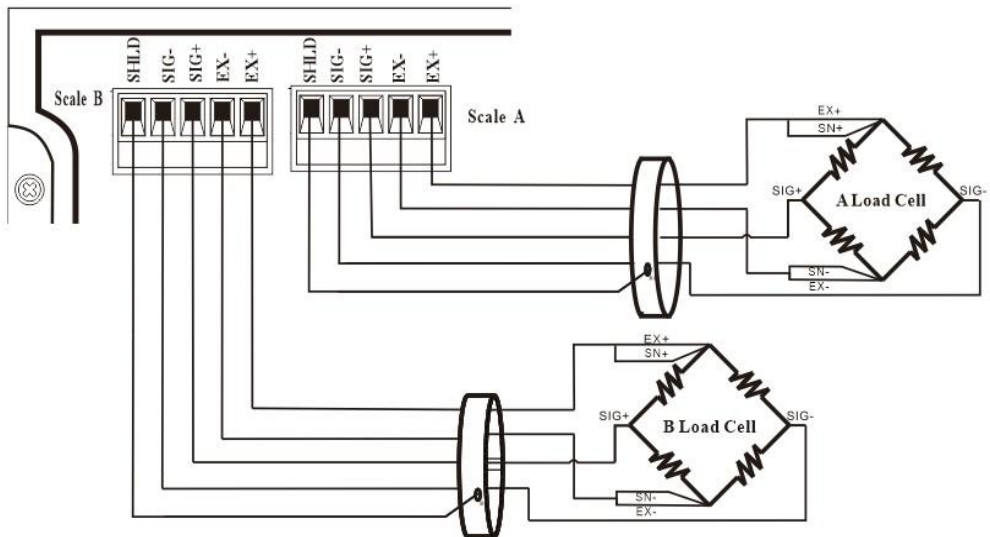

EX+: Excitation+ EX-: Excitation- SN+: Sense+ SN-: Sense- SIG+: Signal+ SIG-: Signal-

2.3 I/O Module Port Connection

GM9907-LD bagging controller controls 28 lines I/O (12 input and 16 output). It uses optoelectronic isolation technology to transfer data. The I/O signal input is low level effective, and the output is open-collector mode. The driving current can reach 500mA and the full load current is up to 3A, and Terminal connection is shown as below:

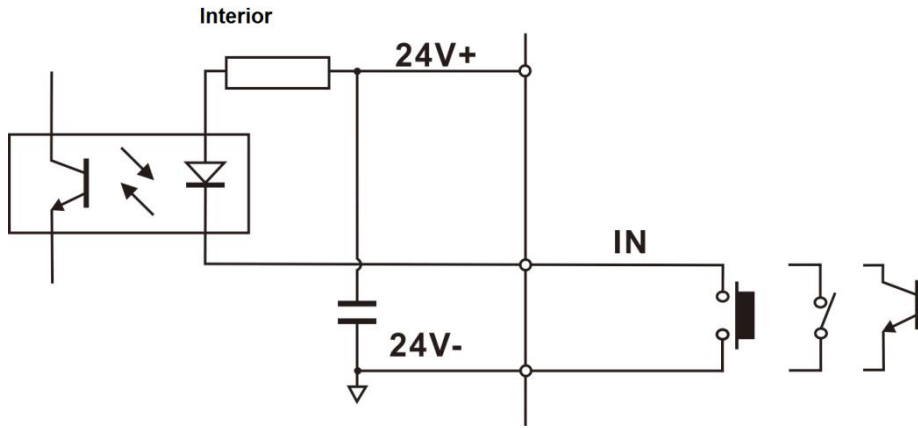

I/O Module Input port diagram

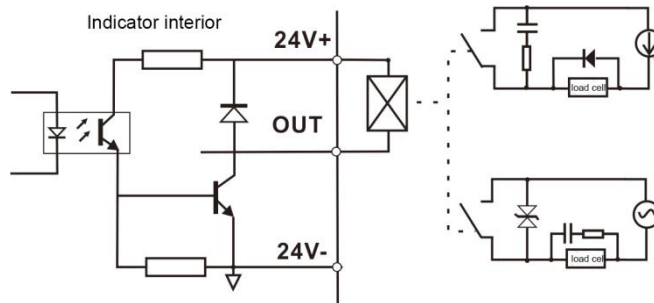

I/O Module output connection diagram

I/O module value of **GM9907** is user-defined to facilitate wiring and some special applications. Please refer to section 4.8 for I/O module.

2.4 Power Supply Connection

GM9907 bagging controller use 24V DC power supply. The connection is shown in the figure below:

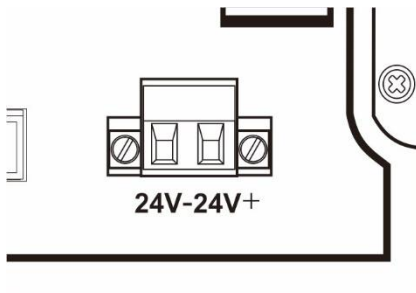

Power terminal diagram

24V+ connect DC+, 24V- connect DC-.

Note: this product use 24V DC power supply, use 220V AC power supply will permanently damage the controller and cause danger.

2.5 Serial Port Connection

GM9907-LD can provide two serial ports. It is depicted below. One for RS-232 (Port TX、RX、GND); the other is RS-485, (Port A、B、GND)。serial ports support: MODBUS mode、Cont mode and Print format.

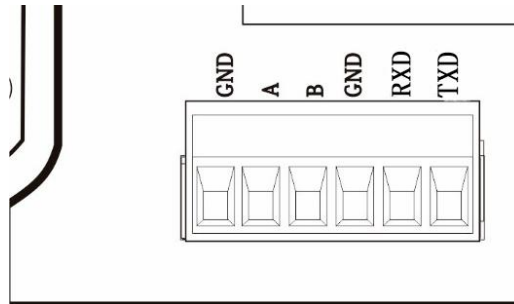

Controller and computer connection diagram:

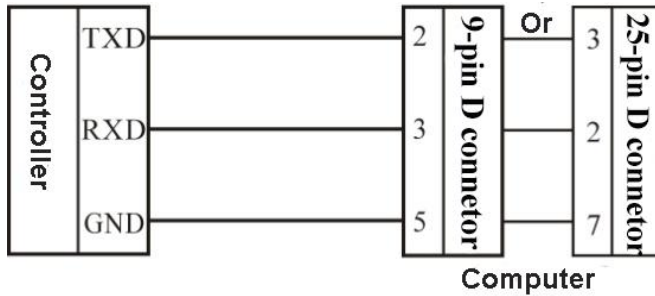

Connection between GM9907-LD and a host computer (RS-232):

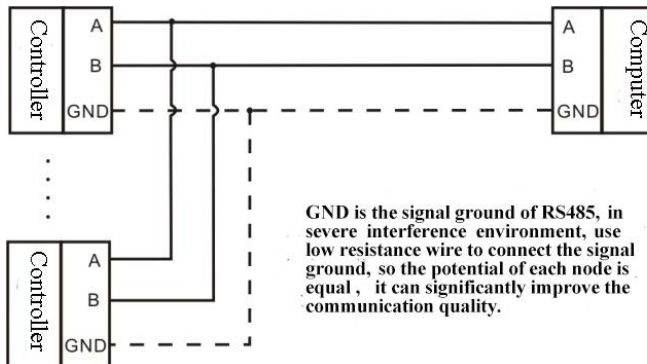

Connection between GM9907-LD and a Host Computer (RS-485)

2.6 Touch Screen Calibration

Fisrt use new controller or laid-aside for a long time need to calibrate touch screen, calibrate instruction:

GM9907-LD power on, long press any point on the touch screen at the same time,

system turn to touch screen calibrate interface, long press cursor position on touch screen, cursor position calibrate finish, after the interface displays the coordinates of this point, enter to next calibrate automatically. Follow cursor position changes long press accordingly, calibrate finish, and interface show 5 calibration point coordinates, enter to main interface automatically. If enter the calibration interface of the touch screen by mistake, press the "cancel" button in the lower right corner to exit the interface.

3. User Permission Description

In order to prevent wrong operation causing **GM9907-LD** working improperly, it provides three rights (operators, administrators and system administrators) : System administrator can perform all operations (not open to users). The operator and administrator rights restrictions are as follows:

Permission	Operation
Operator	Can check all the parameters.
	Can set receipt parameter's value parameters and time parameters, I/O module test.
	Can set batch in main menu, and the total quantity of dispatching.
Administrator	All operator privileges are available.
	Can calibration,start over/under, Free Fall correction and Adaptive function,set weight parameters,I/O module define,set language and time,correct computer mode parameter.
	Can modify open Peripherals parameters

Permission description:

- ◆ After the controller is power on, enter the permission selection interface, and enter the main interface after selecting the permission
- ◆ Operator have four login method : Single operator login, multiple operator login, single operator keyword login, multiple operator keyword login.
- ◆ In **【System Trial】【Style setting】** parameter , set the multi-operator login function ON/OFF, turn ON, set the number of operator logins. This is used to set the login mode for multiple operators.
- ◆ In **【System Trial】【Style setting】** parameter, set login operator need keyword ON/OFF, turn ON, this is used to set whether a password is required for operator login.
- ◆ Multi-operators are set to 8, operator~operator 8
- ◆ The operator cumulative data of single operator and multiple operators are merged into the user cumulative operator column in **【statistics】**
- ◆ Click the permission in the foreground, the logout pop-up window will pop up, you can logout the current permission to return to the permission selection interface. After the power is powered off and the system restarts, the rights are automatically deregistered.

4. Menu

Click the menu to check or revise parameters. The menu is shown as follows.

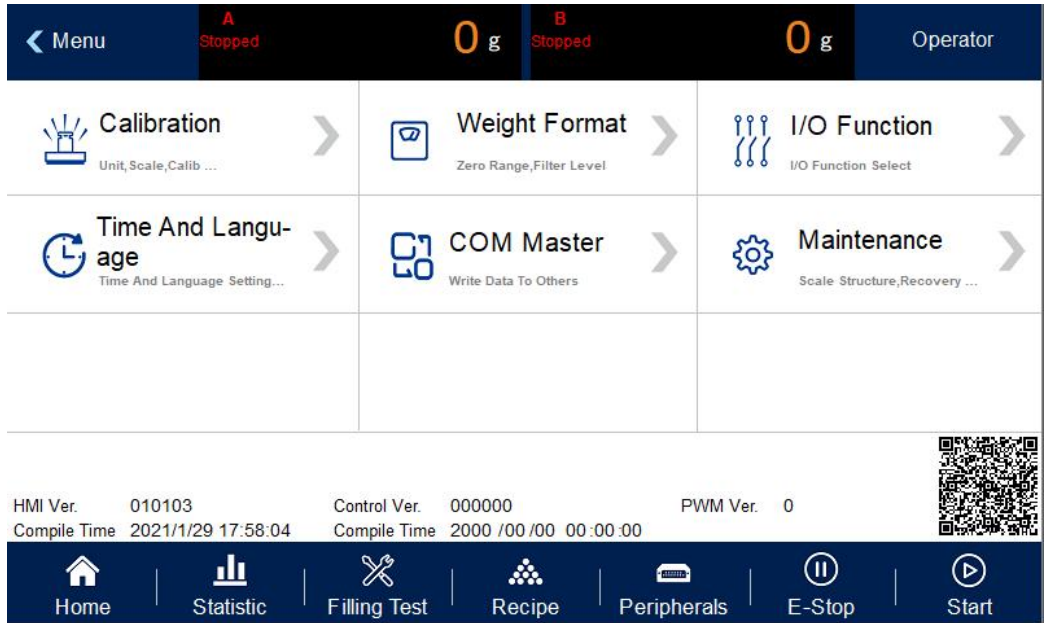

- ◆ Click each parameter item to view and set the home parameter information under the current parameter item.
- ◆ Click top left of interface to exit the current interface and return to the previous page.

Menu	Parameter	Parameter list	Description
Menu	Calibration	Weight calibration	Use weight to calibrate
		A material Calibration	Use material to calibrate
		B material Calibration	
	Weighing parameters	Zeroing range/Filter level setting	Set weight relevant parameters, such as zeroing range, stable parameters etc.
	I/O Module	Input definition	Input port definition.
		Output definition	Output port definition.
	Time and language	Language setting	Default English, Mandarin and English optional

		Time setting	Screen time setting
	COM Master	Master	Write Data To Others
	Motor	Fill Gate Driver	Fill Gate Driver parameters setting
		Clamper mode	Clamper motor parameter setting
		DISC Parameter	DISC motor Parameter setting
	Maintenance	Scale Structure	Scale Structure, Working Mode etc relevant setting
		Peripherals Select	Peripherals Select ON/OFF setting
		Communication	Serial ports, ethernet, print etc setting
		User Logic Program	Aux.logic parameter, 6 group output logic parameter setting
		Reset	All parameters reset to factory setting
		Hardware Test	To test all input and output connection.
		Display Style	Display time setting
		Firmware Update	Firmware Update
		System Info.	Check calibration times and check code

4.1 Calibration

Calibration should be done when a GM9907-LD controller is used at the first time, or the preset parameters can't meet the user's demand due to change any part of the weighing/bagging system.

To enter calibration parameter need to input correct password as it is protected by password per International Standard. Calibration password can be modified by clicking any parameter requiring permission. (Initial password: **0000**)

Calibration interface, provide two kinds of calibration methods: weight calibration and material calibration. The calibration steps are as follows:

Calibration parameter	Item parameter	Description
	1. Unit	Initial value: kg . Option: g/kg/t/lb .
	2. Decimal point	Initial value: 0.00 . Option: 0~0.0000.
	3 Minimum	Initial value: 1 . Option: 1/2/5/10/20/50 .

	division	
	4 Full capacity	Initial value: 100.00 ; full capacity \leq minimum division*100000
Test Weight Calibration	<p>Calibration function is the calibration method using weights in site. The calibration steps for the weights of A and B are as follows</p> <p>Step 1 : According to the demand to choose units, decimal point, indexing value and other weighing parameters.</p> <p>Step 2: Empty the bucket and click 【Empty scale calibration】. This step is the zero point of calibration, requirements are: the bucket is empty, the scale body is stable</p> <p>Step 3: Put the weights on the weighing table, and when the weighing table is stable, click 【Weight Calibration】, input the weight of the weights in the bullet frame, and click 【OK】 to complete the calibration of the weights</p>	
A.B material calibration	<p>Material calibration function is in the site is not convenient to use the weight calibration method. Steps as follow:</p> <p>Step1 : Clear the scale table, wait for the mV to stabilize, then click 【Empty scale calibration】. This step is to zero point of calibration, requirements are: bucket is empty, the scale body is stable.</p> <p>Step2: Click 【Manual Feeding】, then the feeding door opens, add some materials to the metering bucket, click 【Manual Feeding】 again, close the feeding door. (Note: if the manual feeding time (Step2 time setting is manual feeding time) is not set to 0, the feeding door will be automatically closed after the manual feeding time is up).</p> <p>Step3: Click 【Record】 to display the gain millivolts after manual Feeding.</p> <p>Step4: Click 【Discharge】. When the discharge door opens, the background will record the current relative millivolt. Weighing the discharge material with electronic scale and recording the data.</p> <p>Step5: Click 【Calibrate】 to input the weighing data and click OK. Material calibration is finished.</p>	

4.2 Recipe Parameter

Click the formula on the main interface to enter the 40 formula selection interface, which displays the formula number, name and target value.

- ◆ Click the recipe number button on the right to switch the recipe number.
- ◆ Click on each recipe bar to enter the corresponding recipe parameter interface.
- ◆ Click the upper left to return to the upper interface

Recipe	Parameter	Description
--------	-----------	-------------

Item			
Quantitative value	Packaging weight value setting.		
	1. The AB target value is switched separately	Optional on and off. when is on, the target values of A and B are set respectively; when is off, sets the total target value. Initial value: off.	
	2. Total target value	“Individual Target Mode” When turn to off is valid	
	3. Zero zone value	In quantitative process, if the weighing value \leq Near Zero Band, starts discharge delay timer.	
	4. Scale A	a. A. Target value	“Individual Target Mode” When turn on is valid
		b. Co-Fi Remain	In quantitative process, if the weighing value \geq target value – Coarse Flow leading quantity, closing Coarse Flow fill.
		c. Me-Fi Remain	In quantitative process, if the weighing value \geq target value – Medium Flow leading quantity, closing Medium Flow.
		d. Free Fall	In quantitative process, if the weighing value \geq target - free fall value, closing Fine Flow.
	5. Scale B	a. B. Target value	“Individual Target Mode” When turn on is valid
		b. Co-Fi Remain	In quantitative process, if the weighing value \geq target value – Coarse Flow leading quantity, closing Coarse Flow fill.
		c. Me-Fi Remain	In quantitative process, if the weighing value \geq target value – Medium Flow leading quantity, closing Medium Flow.
		d. Free Fall	In quantitative process, if the weighing value \geq target - free fall value, closing Fine Flow.
Time parameters	Used to set time - related parameters in the feeding process		
	1. A. COMP. Inhibit Timer (Co-F)	At the beginning of the quantification, the coarse feeding has been effective during this time to avoid overshooting without weight judgment Initial value: 900; range: 0~9999 (ms)	
	2. A. COMP. Inhibit Timer (Me-F)	After the end of coarse feeding, in this period of time, in order to avoid overcharging without weight judgment, adding has been effective. Initial value: 900; range: 0~9999 (ms)	
	3. A. COMP. Inhibit Timer (Fi-F)	After the end of the Medium feeding, in this period of time, in order to avoid overshoot without weight judgment, fine feeding has been effective. Initial value: 900; range: 0~9999 (ms)	

	4. B. COMP. Inhibit Timer(Co-F)	At the beginning of the quantification, the coarse feeding has been effective during this time to avoid overshooting without weight judgment Initial value: 900; range: 0~9999 (ms)
	5. B. COMP. Inhibit Timer(Me-F)	After the end of coarse feeding, in this period of time, in order to avoid overcharging without weight judgment, adding has been effective. Initial value: 900; range: 0~9999 (ms)
	6. B. COMP. Inhibit Timer(Fi-F)	After the end of the Medium feeding, in this period of time, in order to avoid overshoot without weight judgment, fine feeding has been effective. Initial value: 900; range: 0~9999 (ms)
	7. Filling Start Delay	In the with bucket mode, at the beginning of the quantitative process, after this delay time, the controller will conduct stability assessment and zero clearance (if it does not meet the conditions of zero clearance interval, then it will not be stable and zero clearance), and then start the feeding process; Without bucket mode, after the bag clamping is completed, after this delay time, the controller is stabilized and peeled Initial value: 0.5 ; range: 0.0~99.9 (s)
	8.Result Waiting Timer	When the waiting mode is selected as " Result Waiting Timer ", fine feeding is turned off (or the over/under is turned on and the over/under alarm is over), and the setting is started. After this holding time, the setting is considered to be over and the next process is entered. Initial value: 0.5 ; range: 0.0~99.9 (s)
	9. Discharge Delay Timer	In the discharge process, when the weight value of the scale bucket is less than the zero zone value, the delay is started, and the discharge signal is closed after the delay. Initial value: 0.5 ; range: 0.0~99.9 (s)
	10. DISC Interlock Timer	In the bucket combination mode, the discharge interval time value of balance A and B. Initial value: 0.5 ; range: 0.0~99.9 (s)

	11. Hanger Up Delay Timer	In the no-bucket mode, the delay is executed after the rise signal is issued. Initial value: 0.0 ; range: 0.0~99.9 (s)
	12. Hanger Down Delay Timer	In no-bucket mode, the waiting delay is started after the end of the delay Initial value: 5.0 ; range: 0.0~99.9 (s)
	13. Bag Locked Delay Timer	After giving the bag clamping signal, after this delay, the controller determines that the bag clamping action is completed Initial value: 0.5 ; range: 0.0~99.9 (s)
	14. Unlock Bag Pre-Delay Timer	After the discharge of Net weigher is finished, the unlock bag signal is output after this delay time. After the completion of the no-bucket mode setting (patting the bag), the unlock bag signal is output after this delay. Initial value: 0.5 ; range: 0.0~99.9 (s)
	15. Supplement Empty On Timer	Gross Weigher mode is effective. Scale A detects that the feeding level is effective after the bag is clamped, and then scale B also clamps the bag within this time. In this case, even if the feeding level is invalid, then scale B should also start feeding Initial value: 4.0 ; range: 0.0~99.9 (s)
Over/ Under	Over/Under alarm parameter setting	
	1. Over/Under detection ON/OFF	ON/OFF. Judge over/under when in quantition process.
	2.Over/Under pause ON/OFF	ON/OFF. If set ON, the controller will stop if over or under. Input emergency stop and return to stop status, clear alarm information. Or input clearing alarm, press ENTER to procees quantitation.
	3. Over/Under detection Timer	When the function of over/under is turned on, the time is started for over detection after the material feeding of each scale is finished. After the delay, the controller will stabilize and output over/under Initial value: 1.0 . Range: 0 ~ 99.9s. (s)
	4.Over value	In value process, if the weighing value \geq target value+ OverLimit Value, judged as OverLimit. Initial value: 0 .

	5. Under value	In value process, if the weighing value \leq target value- UnderLimit Value, judged as UnderLimit. Initial value: 0 .
	6.Supplement material ON/OFF	Supplement material judgement ON/OFF. ON: Slow jogging of material when under. (According to supplementary times). OFF: Not supplement materials.
	7.Supplement material times	If under, start to supplement materials as per setting times. Initial value: 1 . Range: 1~99.
	8.Effective supplement time	Effective jogging time within a cycle period. Initial value: 0.5. Range: 0 ~ 99.9s.
	9.Ineffective supplement time	Ineffective jogging time within a cycle period. Initial value: 0.5. Range: 0 ~ 99.9s.
Free fall correction	For setting parameters automatically adjust the gap	
	1.Free fall correction ON/OFF	Correct according to actual falling materials.
	2 Correction sampling times	Catch the average of free fall value and set as correction basis. Initial value: 1. Range: 1~99.
	3.Free fall correction range	When this drop value exceeds the set range, it will not be included in the arithmetic average range. Initial value: 2.0 . Range: 0.0 ~ 9.9(Percent of the target)
	4.Free fall correction magnitude	Every fall correction magnitude; Option: 100%, 50%, 25% . Initial value: 50%.
Adaptive	1. Adaptive ON/OFF	Adaptive function, open the switch after the operation process automatically adjust the controller coarse, fine, increase the amount of advance and stop time. Optional, double speed, three speed. Initial value: off. (Note: 1. The fall correction and adaptive function cannot be turned on at the same time. If the adaptive function is enabled, the fall correction function must be turned off. 2. When the first scale adapts to start, it must ensure that the scale body is stable and the current weight is zero.
	2. Adaptive Level	The lower the grade, the faster the feeding speed, the relatively lower the accuracy. Initial value: 3; range: 1~5
	3.Parameters update ON/OFF	When opened, the change value of coarse, medium and fine plus advance quantity will be updated to the value of quantitative parameter;When off, quantitative parameter values cannot be updated

4.3 Weighing Parameter

In the menu interface, click the **【Weighing】** menu to enter the current parameter item to view and set the home parameter information.

Parameter	Item parameter	Description
Weighing parameters	1. Zero Range	Zero Range Initial value: 50; range: 1~99 (Percentage of full scale)
	2. Stable range/Timer	In the time of stability, the weight change range within this setting value is judged to be stable by the controller Stable Range initial value: 2; range: 0~99(d). Stable Timer initial value: 0.3; range: 0.1~9.9 (s)
	3. TrZero Range/Time	Weight values within this range, the controller automatically displays zero. Is 0, zero tracking is not performed. TrZero Range initial value: 0; range: 0~9(d). TrZero Time initial value: 2.0; range: 0.1~99.9 (s)
	4. PWR-ON Zero	On/off is optional. When "on", the controller will automatically perform zero clearing operation (the weight in the scale bucket meets the zero clearing range). Initial value: off.
	5. Result Check Mode	Wait Stable: After the fine feeding is closed, the weight is stable and the value setting process is completed Time Delay: After the slow feeding is closed, the valuing process is completed after the fixed value holding time initial value: Wait Stable
	6. PreFill Zero Interval	The number of times the packaging process is completed and a zero clearance is carried out. When entering the running state, the controller is not reset during the first packaging process. initial value: 0; range: 0~99. (Note: This parameter is only valid for Net Weigher mode and bulk scale mode)
	7. Manual DISC To ACUM	Optional on/off; Set to "on", manual discharge weight value is included in the cumulative value. Initial value: (Note: This parameter is only valid for Net Weigher mode and bulk scale mode)

	8.A/D Sample Rate		A/D Sample Rate, 120 times/s, 240 times/s, 480 times/s, 960 times/s optional, initial value: 240 times/s.
	9. D-Filter Strength		AD Digital filtering parameters: 0: no filtering;9: The filtering effect is strongest.Initial value: 7.Range: 0 ~ 9
	10. Vib-Filter		secondary filtering based on digital filtering. Initial value: 0.Range: 0 ~ 9
	11. Dynamic Filter parameters	Dynamic Filter	In the packaging process, whether to carry out filtering operation switch and set "on", the following parameters are valid;Initial value: on.
		Filling Filter	Filtering parameters in the feeding process: 9: The strongest filtering effect. Initial value: 4; Range: 0 ~ 9.
		Result Check Filter	Filtering parameters in the feeding process: 9: The strongest filtering effect. Initial value: 7; Range: 0~9
		Discharge Filter	Filtering parameters in the discharge process: 9: The strongest filtering effect Initial value: 3; Range: 0~9。
12. Result Hold		Optional on/off;Set to "on", the weight of the controller is fixed at the weight of the fixed value after the fixed value, and the real-time weight will be displayed when the weight of the discharge (loose bag) is lower than half of the target value.Initial value: off.	

4.4 Maintenance

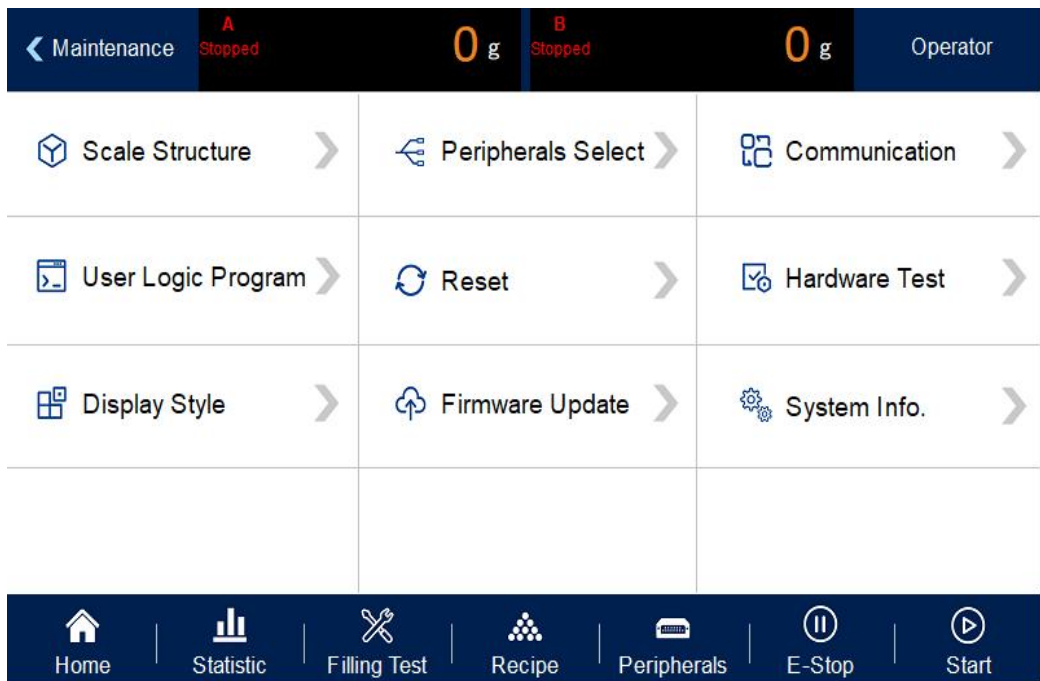

4.4.1 Scale Structure

Item parameter		Description
2. Net Weigher parameter setting	a. Scale structure	Net Weigher; Net Weigher / Gross Weigher / bulk scale mode
	b. Working mode	Net Weigher is optional: AB double scale, alone A scale, alone B scale, double clip bag AB independent, d double clip bag AB combination; Initial value: AB double scale.
	c. Filling control method	Single feeding/combination feeding is optional; Initial value: Combination feeding. Combination feeding: fast feeding large, medium and small feeding port at the same time; Add medium and small feeding port at the same time feeding; Slow time small feeding port feeding. Separate feeding: fast and large feeding port feeding; Add when the feeding port feeding; Slow time small feeding port feeding.
	d. Filling mode	0 Air Drived mode; 1 Step motor feeding 2 motor mode
	e. Clamper Driver	0 Air Drived mode; 1 Step motor; 2、 Normal Motor(Two Pos. Signal); 3 Normal Motor(One Pos. Signal) Default value: 0 Air Drived

	f. Discharge mode	0 Air Driven mode; 1 Step motor; 2 Normal Motor(One Pos. Signal) 3 Normal Motor(Two Pos. Signal); 4 Normal Motor Rotating Default value: 0 Air Driven
	g. Manual Unlock Bag	Optional on/off; Set to "on", in operation, need to manually control unlock bag. Initial value: off.
	h. Hopper Capacity	Net Weigher mode is effective. The Hopper Capacity is weighed and the number of discharging times is calculated with the target value.
	i. Bag Lock Required (Manual DISC)	In Net Weigher mode stop state, set to "on", manual unloading, the bag clamping signal switch should be judged, after the bag clamping is allowed to discharge.Initial value: off. Note: In the dual bucket and double clip bag AB independent and double bucket and double clip bag AB combination mode, manual unloading can judge the loose bag switch is on. During unloading, the clip bag status of scale A and scale B will be detected respectively.
2. Gross Weigher parameter setting	a. Scale structure	Gross Weigher; Net Weigher / Gross Weigher / bulk scale mode
	b. Working mode	Single A scale Gross Weigher, Single B scale Gross Weigher, A/B NoneHopper, A+B NoneHopper
	c. Filling control method	Single feeding/combination feeding is optional; Initial value: Combination feeding. Combination feeding: fast feeding large, medium and small feeding port at the same time; Add medium and small feeding port at the same time feeding; Slow time small feeding port feeding. Separate feeding: fast and large feeding port feeding; Add when the feeding port feeding; Slow time small feeding port feeding.
	d. Filling mode	0 Air Driven mode; 1 Step motor feeding; 2 Motor mode
	e. Clamper Driver	0 Air Driven; 1 Step motor; 2 Normal Motor(Two Pos. Signal); 3 Normal Motor(One Pos. Signal) Default value: 0 Air Driven

	f. Manual Unlock Bag	Optional on/off; Set to "on", in operation, need to manually control loose bag.(Note: in the combinatorial mode of AB without bucket, this parameter and the allowable loose bag switch in operation cannot be opened at the same time) Initial value: off.
	g. G/N Packing	Gross/net weight packaging is optional; In the net weight packaging mode, the tare weight is cleared at the beginning of quantification, and the quantitative packaging process is carried out with the net weight value. Initial value: net weight packing.
	h. Unclock Bag(None Hopper)	Loosen bag mode optional: close, simultaneously loose bag normal mode, simultaneously loose bag fast mode.Initial value: Off. (Note: Only the combinatorial mode without bucket AB has this parameter) 1. Loose bag normal mode For example, one scale has finished feeding another scale has not finished feeding, waiting for the completion of another scale at the same time after the two loose bags. If a scale has finished feeding, the other scale is not in the bag (feeding) state, then do not wait for another scale, this scale directly loose bag. 2. loose bag fast mode In this mode, scale A is placed in front of scale B.For example, scale A will directly loosen the bag without judging whether B is finished after feeding. After the completion of feeding, B shall judge whether A is in the state of bag clamping (feeding). If A is feeding, B shall wait for A to loosen the bag after the completion of feeding.If A is not feeding, B will loosen the bag without waiting.
	i. Disable Unlock Bag When Running	Optional on/off; Set to "on", no bucket mode, feeding, need to manually control loose bag. Initial value: off. (Note: In the combinatorial mode of AB without bucket, this parameter and manual loose bag switch cannot be opened at the same time.)
3.Bulk scale	a. Scale structure	Net Weigher; Net Weigher / Gross Weigher / bulk scale mode

mode parameter setting	b. Working mode	Bulk is optional: Bulk single hopper A , Bulk single hopper B, Bulk scale AB independent, Bulk scale AB Interlock; Initial value: Bulk scale AB independent.
	c. Filling control method	Single feeding/combination feeding is optional; Initial value: Combination feeding. Combination feeding: fast feeding large, medium and small feeding port at the same time; Add medium and small feeding port at the same time feeding; Slow time small feeding port feeding. Separate feeding: fast and large feeding port feeding; Add when the feeding port feeding; Slow time small feeding port feeding.
	d. Filling mode	0 Air Drived mode; 1 Step motor feeding; 2 Motor mode
	e. Discharge mode	0 Air Drived mode; 1 Step motor; 2 Normal Motor(One Pos. Signal) 3 Normal Motor(Two Pos. Signal); 4 Normal Motor Rotating Default value: 0 Air Drived
	f. Hopper Capacity	The bucket mode is effective. The Hopper Capacity is weighed and the number of discharging times is calculated with the target value.
	g. Flow window length	Sampled times is used to calculate the current flow value. Initial value: 5 ; range: 1~6 .

4.4.2 Peripheral ON/OFF

This parameter sets the switch of instrument peripheral. If set on, peripheral parameters of the main interface can be set. Refer to Chapter 4.4 for specific peripheral parameters.

Parameter	Item parameter	Description
Peripheral ON/OFF	Pat bag parameter	Bag mode selection: Initial value: Do not pat the bag. Optional: Net Weigher mode: no patting bag/patting bag after fixed value is optional Gross Weigher mode: no patting bag/after fixed value

		beat bag/feeding in the bag/feeding in the bag after fixed value all patting bag
	Sewing Device	Whether to turn on the function of the sewing machine. On and OFF are optional. When turn to ON, the peripheral device can start to sew the bag, and the parameters of the sew machine can be set.
	Conveyor	When turn on the conveyor function. On and OFF are optional. When turn ON, the external device starts the function of conveyor and the parameters of conveyor can be set.
	Coding Device	Whether to enable the coding function. On and off are optional. When on, the peripheral starts coding function, and the coding parameters can be set.
	DISC Shaking Switch	Whether to open the discharge shaking switch. Optional on and off. When on, the external device opens the discharge shaking function, and the DISC Shaking parameters can be set.
	Auxiliary Pulse Switch	Whether to enable auxiliary pulse function. On and off are optional. When on, this function is enabled by peripherals and auxiliary pulse parameters can be set.
	Fill&DISC Monitor	Whether to turn on the Fill&DISC Monitor. On and off are optional. When on, the peripheral enables this function, and the timeout alarm parameter can be set.

4.4.3 Communication Setting

GM9907 provides two serial communication interface; See Section 2.5 for the definition of serial port output; Correct setting of port parameters can be used for communication.

Communciation parameters	Item Parameters	Description
Serial port parameters (Serial port 1. RS232 Serial port 2. RS485)	1. ID No.	Initial value: 1. Option: 1~99.
	2. Communication mode	Initial value: Modbus-RTU . Modbus-RTU / Print / Continuous mode / Re-ContA / Re-ContB
	3. Baud rate	Initial value: 38400 ; 9600/19200/38400/57600/115200

	4. Data format	Initial value: 8-E-1 (8 data bits - even parity -1 stop bit). Option: 8-E-1/8-N-1/7-E-1/7-N-1.
	5. Modbus Hi-Lo	Modbus communication mode: Initial value: AB-CD (High word first). Option: AB-CD (High word first) / CD-AB (Low word first).
Ethernet parameters	1. Communication Mode	Fixed: Modbus-TCP
	2.modbus-TCP Hi-Lo	Initial value AB-CD . Range: AB-CD (Hi ahead) / CD-AB (Low word first)
	3. port number	Initial value 502. Range 1~65535
	4.IP	Initial value 192 Range 0~255
		Initial value 168 Range 0~255
		Initial value 101 Range 0~255
		Initial value 246 Range 0~255
5.MAC	BC.66.41.9x.xx.xx	
Print	1. Auto Print	Optional on/off;When "Open" is selected, the packaging result will be automatically printed out each time the packaging is completed (the serial port is required to select "Print") Initial value: off.
	2. Printer Format	Initial value: 24 columns to print; 24 columns to print / 32 columns to print
	3. Printing Language	Initial value: Chinese print; Chinese/English printing is optional
	4. Print Empty Line Nos.	Number of lines of paper after printing, initial value: 3; Optional 0 ~ 9.

4.4.4 Auxiliary Logic Function

Auxiliary logic programming function, can define up to 6 sets of auxiliary logic trigger signals, and can set the effective time and output port after the auxiliary logic signal is triggered, can configure simple logic signal output for the control of other auxiliary equipment, 6 sets of auxiliary logic signals can also control each other.

Auxiliary logic programming	Parameter	Descriptions
-----------------------------	-----------	--------------

parameter 1~6		
1. Logic type (1~6)	OFF (default)	Select the type of auxiliary logic programming signal based on the logic to be implemented.
	Delay on	
	Delay to disconnect	
	Delay on Delay to disconnect	
	Invalid-valid Jump trigger	
	Valid-Invalid jump trigger	
2. Logic (1~6) trigger signal	Custom trigger input (default)	After any one of the 1-12 channels is set as the trigger signal, the input port will be fixed as the trigger signal.
	>=or<=weight trigger	After setting the trigger condition, the current weight value is compared with the set weight threshold, and the output is triggered when the condition is met.
	IN port 1~12	If any path in the input port from 1 to 12 is set as the trigger signal, the input can be either the trigger signal or the function signal of the input port.
	I/O Module output define	After the trigger signal is set as "an internal function signal", the output is triggered according to the function signal.
3. Trigger input port	IN1~12	Initial value: undefined Select the input port of the ON/OFF corresponding to the function signal. The input port "0 undefined" means that the function is not defined.
4. Output signal port	OUT1~16	Initial value: undefined Select the output port of the ON/OFF corresponding to the function signal. The output port "0 undefined" means that the function is not defined.
5.Delay connect time	Unit:s	Initial value: 0.0; Range: 0.0~99.9 After the trigger signal is valid, the logic output signal is valid only after the delay.
6. Delay disconnect time	Unit:s	Initial value: 0.0; Range: 0.0~99.9 After the trigger signal is invalid, the logic output signal will be invalid after the delay.
7. Output valid time	Unit:s	Initial value: 0.0; Range: 0.0~99.9 The duration after the logic output signal outputs a valid signal becomes invalid at the end of time.
8.Logic	Unit:kg	Initial value: 0.0; Range: 0.0~Maximum range

threshold weight		Set the weight value, compare the current weight with the threshold weight, and trigger when the weight value trigger condition is met.(valid when the trigger signal selects ">= or <= weight value")
---------------------	--	--

Delay ON

- When selected to delay connection **【By Trigger Function】**, the operation is as follows:

1. Set parameters and I/O Module: type select **【delay on】**, if choose **【By Trigger Function】** trigger input port is defined as "1" (I/O Module input port 1 is shown as "auxiliary logic trigger input 1"), logic output port is defined as "1" (I/O Module output port 1 is shown as "auxiliary logic output 1"), set **【Logic6 Delay ON timer】** for 2 seconds.

2. Operation: trigger signal input 1 valid, start the delay connection time, and continue to be valid until the delay connection time 2s ends, the logic output signal port 1 outputs valid, until the trigger signal input 1 is invalid, the logic output signal port 1 also becomes invalid. Refer to diagram below

- When selected to delay connection **【Input Port 1-12】**, operation is as follows:

1. Set parameters and I/O Module: trigger signal choose "input port 1" (can see I/O Module input port 1 is shown as " the definition of the original unchanged", assuming the original definition is started, the function of the input port 1 can be " started "or" signals trigger"), logic output port is defined as 1 (can see the I/O Module output port 1 is shown as " auxiliary logic output 1 "), set the **【 time delay on 】** as 2 seconds.

2. Operation: trigger signal input 1 valid (start is also valid, the output of the controller operation is valid), start the delay connection time, and continue to be valid until the end of the delay connection time 2s, the logic output signal port 1 is valid, until the trigger signal input 1 is invalid, the logical output signal port 1 is also invalid. The controller will continue to run until an emergency stop signal is given.

- When select delay on **【I/O Module output Trigger Function】**, operation is as follows

1. Set parameters and I/O Module: trigger signal is "run" (I/O Module output can be defined or not), the logic output port is defined as 1 (can see the I/O Module output port 1 is shown as auxiliary logic output 1), and the **【delay on time】** is set to 2 seconds.

2. Operations: after input "start", "run" the output signal is valid, begin **【delay on time】**, valid until 2 s delay on time after the logic output signal output port 1, until the "stop or pause" and effective "run" after the output signal is invalid, logic output signal port 1 void.

- When select delay on **【>= or <= weight value trigger】**, operation is as follows:

1. Set the corresponding threshold weight, logic output port is defined as 1 (it can be seen that the output port 1 of the I/O Module is shown as the auxiliary logical output 1), and the **【delay on time】** is set to 2 seconds.

2. Operation: when weight value \geq or \leq logic 1 threshold weight is set to valid,

starts **【delay on time】**, It will remain in valid until the delay time 2s is over, logic output signal port 1 outputs valid, Port 1 of logic output signal is not valid until the current weight < or > logic 1 threshold weight is set.

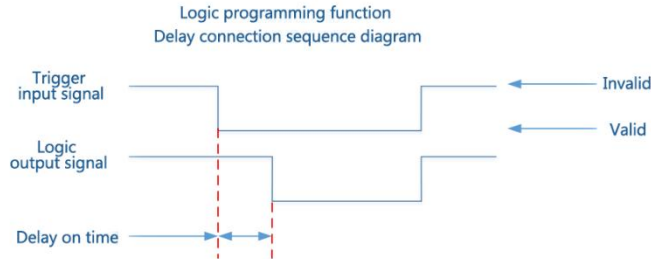

Delay off

Relevant parameters : type selections**【Delay off】**, choose**【Trigger signal】**, set**【Trigger input port】**, **【Logic output port define】**, **【Delay off time】**. Operations refer to “Delay on”. Output functions as below:

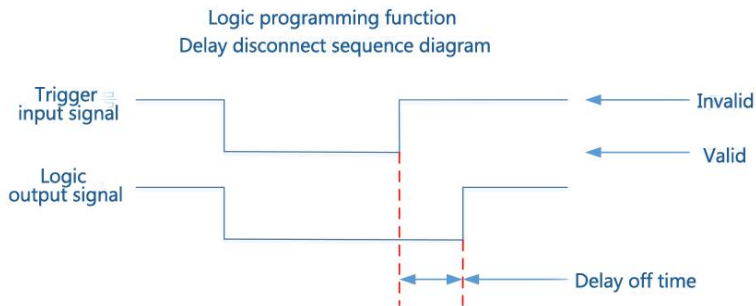

Delay on and delay off

Relevant parameters : type selections **【Delay ON&OFF】**, choose **【Trigger Type】**, set **【Trigger input port】**, **【Logic output port define】**, **【Delay on】**, **【Delay off】**. Operations refer to “Delay on”. Output functions as below:

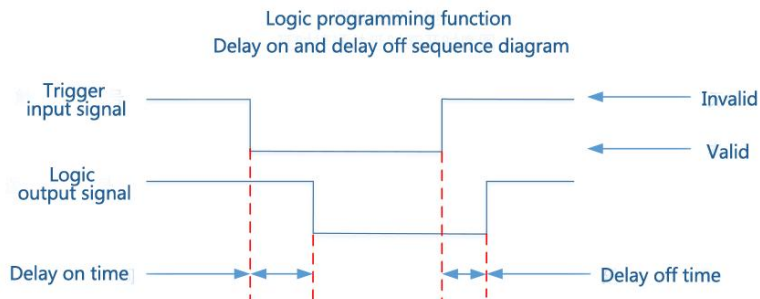

ON Edge Trigger

Relevant parameters : type selections **【ON Edge Trigger】**, choose **【Trigger Type】**, set**【Trigger input port】**, **【Logic output port define】**, **【Delay on】**. Operations refer to “Delay on”. Output functions as below:

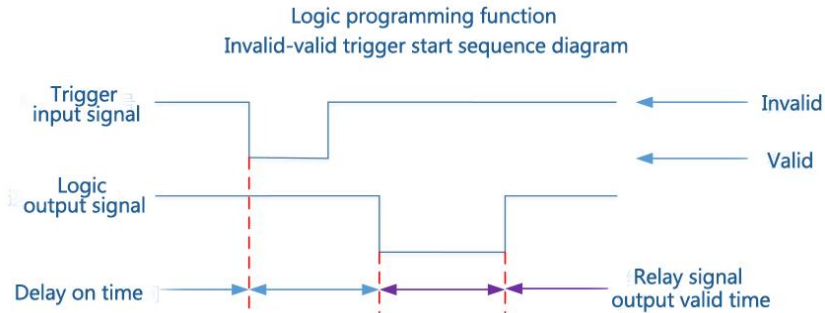

OFF Edge Trigger

Relevant parameters : type selections **【OFF Edge Trigger】**, choose **【Trigger signal】**, set**【Trigger input port】**, **【Logic output port define】**, **【Delay on】**. Operations refer to “Delay on”. Output functions as below:

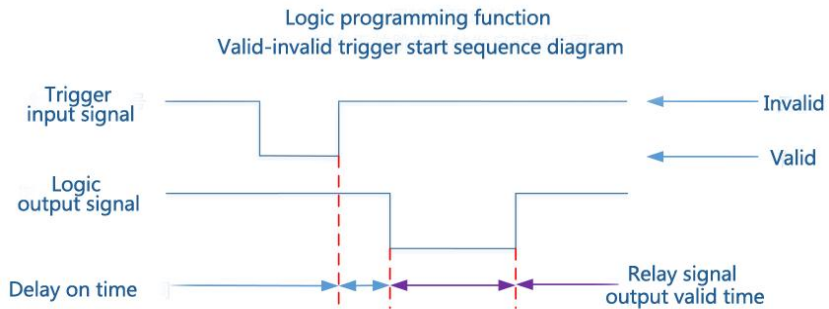

4.4.5 Factory Reset

Administrators and system administrators can restore and backup data through the restore factory in "Maintenance".

Factory Reset	1. All(Except Calibration)	Click this item to restore all parameters of the meter (except calibration parameters) to factory setting values.
	2. All	Click this item to restore all parameters of the controller to factory setting values.
	3. Calibration	Click this item to restore the calibration parameter

	value to factory setting value.
4. Weight And Scale Structure	Click this item to restore the property parameters of weighing and weighing body to the factory setting value.
5. Recipe	Click this item to restore formula parameter value as factory setting value.
6. Communication	Click this item to restore communication setting parameter value is factory setting value.
7. Peripherals And Peripherals Select	Click this item to restore peripheral parameter values and peripheral switch to factory setting values.
8. Motor Config	Click this item to restore motor parameter value to factory setting value.
9. I/O Function	Click this item to restore switch value definition parameter value as factory setting value.
10. User Logic Program	Click this item to restore logic programming parameter values to factory setting values.
11. Parameter Backup	Click this meter to backup the current parameter setting values.
12. Recovery From Backup	Click this meter to restore the parameter value to the latest backup value.
13. Delete Backup	Click this meter to delete the backup parameters.

4.4.6 Hardware Test

This can check whether the output and input interfaces of the controller are normally connected with external devices through IO test. Before I/O test, I/O test switch on, and then I/O test.

Output port test: under the IO test interface, start the output test, that is, after clicking the corresponding output port button, the color of the interface port will light up. The output state of the corresponding external connection should be valid. If it is invalid, it indicates abnormal connection.

Input port test: in the IO test interface, when the external input signal is valid, the corresponding input port color under the interface will be lit up to green. When the external input is valid, the interface has no response, indicating abnormal connection. Check the power input and wiring of the I/O Module, etc.

4.4.7 Display Style

Display Style	1. Screen Save Time	Can set the time to turn off the screen. Default: never; can choose never, 60 seconds, 10 minutes, 30 seconds, 5 minutes, 30 minutes.
	2. MainPage Style	Select MainPage Information Style Data rendering style, quick debugging style is optional.Default: data rendering style.
	3. Permission exit time	Permission exit time setting. can choose 5 minutes, 10 minutes, 20 minutes,30 minutes.
	4. Multiple User Login	Enable multi-user login function to set the number of users logged in
	5. Number Of Users	The multi-user login switch is turned on to set the number of users logging in
	6.Backlight	The screen goes out when the backlight is turned on.
	7.Backlight duration	Turn on the backlight and set the backlight time. When the time is over ,the screen goes out .Click the screen to re-light up. Initial value: 15s; Range: 15~1800.(s)
	8. Clear ACUM Permissions	Clear accumulated rights. Initial value:Operator; Operator, Administrator, System administrator.

4.5 Peripheral Parameter

Click the **【 Peripheral 】** menu bar in the main interface (Note: the corresponding peripheral switch in system maintenance parameters is turned on, and the corresponding peripheral parameters can only be seen)

Peripheral Item	Parameter	Description
Pat bag parameter	Pat bag parameters setting.	
	1. Pat bag mode	Pat bag after hold value;(The peripheral switch mode of this item is: the following parameters can only be used after the set value)
	2. Pat bag before delay	When start to pat bag, output is valid after this delay time.. Initial value: 0.5 range: 0.0 to 99.9s.
	3. Pat bag effective time	Pat bag effective time through a cycle. Initial value: 0.5, range: 0.0 to 99.9 s.

	4. Pat bag ineffective time	Pat bag ineffective time through a cycle. Initial value: 0.5, range: 0.0 to 99.9 s.
	5. Pat bags after valuing	Pat bag times setting after valuing. Initial value: 4, range: 0 ~ 99.
	6. Extra pat bag effective time	Only applied in Gross Weigher mode. One extra ON timer will be added when patting completed. Initial value: 0. Range: 0.0~99.9s. (Note: After patting bag, bag unlocked delay timer should be longer than extra ON timer to ensure bag unlocked after patting bag.)
	7. Pat bag initial weight	Start to pat bag once value reach initial weight. Initial value: 0, range: 0~full capacity.
	8. Pat times in filling	The number of pats corresponding to the weight of the pats is valid in the no-bucket mode. The number of pats is set as a parameter in feeding. If set to 0, no pats are allowed.(Note: When the feeding process enters slow feeding, force the end of the punching bag in feeding, no matter whether the punching bag is completed or not) Initial value: 0, range: 0 ~ 99.
Sewing / Conveyor	1. Sewing ON/OFF	Set to "ON",start sewing function
	2. Sewing Start Delay	After sewing input valid, delay this time, sewing output valid. Initial value:0.5s range 0.0~99.9s
	3. Sewing ON Timer	Sewing output valid time. Initial value: 4.0s Range: 0.0~99.9s
	4. Cutter Start Delay Timer	Cutter output valid time. Initial value: 0.5s Range:0.0~99.9s After sewing ON Timer is over,starts Cutter Start Delay Timer.Initial value 0.5s range 0.0~99.9s
	5. Cutter output valid timer	Cutter output valid timer Initial value:0.5s Range: 0.0~99.9 (s)
	6. Sewing Stop Delay	Cutter work finished, sewing starts, when Sewing Stop Delay is over, it stops. Initial value: 0.5s Range:0.0~99.9s
	7. Sewing de-shaking timer	Prevent the abnormal operation of the sewing machine caused by the photoelectric jitter of the machine

		starting. During the de-shaking time, the photoelectric jitter of the baling machine, but at this time, the output of the baling machine is still valid Initial value: 0.3 Range: 0.0~99.9 (s)
	8. Conveyor ON/OFF	ON/OFF. With conveyor output function if set ON. Initial value: OFF. Valid in Gross Weigher mode. 有斗双夹袋模式、无斗模式下有效。
	9. Conveyor start-up delay	In Gross Weigher mode 有斗双夹袋模式、无斗模式下有效。 , Conveyor start completed after this delay timer. Initial value: 0.5 , range: 0~99.9s .
	10. Conveyor run time	In Gross Weigher mode 有斗双夹袋模式、无斗模式下有效。 , conveyor running time setting. Initial value: 4.0 range: 0 - 99.9s .
	11. B Delayed Before Starting Next Filling	In Gross Weigher mode 有斗双夹袋模式、无斗模式下有效。 , scale B filling delay again. Only valid for scale B, which in order to prevent the immediate filling of the bag after bag locked and causing the bag below to withstand the filling bag. Initial value: 2.0 range: 0 - 99.9s .
Coding /Shaking	1. Coding ON/OFF	ON/OFF. Controller has coding output function if set ON. Initial value: OFF.
	2. Coding start-up delay	Bag locked completed, coding output is valid after this delay. Initial value: 0.5 , range: 0.0 ~ 99.9s .
	3. Coding Duration Timer	Coding output effective time. Initial value: 0.5 , range: 0.0 ~ 99.9s .
	4. Not allow Fill/Discharge When Coding	ON/OFF. Not allow to filling output (Gross Weigher mode) or discharging output (Net Weigher mode) in coding process. Initial value: OFF.
	5. DISC Shaking ON/OFF	When set to "ON", when discharge starts shaking function
	6. Discharge valid time	Discharge patting is on; the valid discharge time is the time from the output discharge signal to the discharge completion when the discharge delay is started. After

		discharge exceeds the valid time of discharge, discharging patting is started. Initial valid:2.0s, Range: 0.0~9.9s
	7. Discharge patting valid time	Initial value: 0.5s, Range:0.0~9.9s (s)
	8. Discharge patting invalid time	Initial value: 0.5s, Range:0.0~9.9s (s)
	9. Discharge patting times	Initial value 10 , range 0~99
Auxiliary pulse parameters	1. Auxiliary pulse ON/OFF	When set to "ON", Auxiliary pulse start
	2. Total execution time of auxiliary pulse 1	Total execution time of auxiliary pulse 1. If it's 0, it loops forever, Initial Value 0, range 0.0~999.9s (s)
	3. Auxiliary pulse 1 valid time	Initial value:10.0s, Range:0.0~999.9s (s)
	4. Auxiliary pulse 1 invalid time	Initial value:10.0s, Range:0.0~999.9s (s)
	5. Total execution time of auxiliary pulse 2	Total execution time of auxiliary pulse 2. If it's 0, it loops forever, Initial Value 0, range 0.0~999.9s (s)
	6. Auxiliary pulse 2 valid time	Initial value:10.0s, Range:0.0~999.9s (s)
	7. Auxiliary pulse 2 invalid time	Initial value:10.0s, Range:0.0~999.9s (s)
	8. Total execution time of auxiliary pulse 3	Total execution time of auxiliary pulse 3. If it's 0, it loops forever, Initial Value 0, range 0.0~999.9min (min)

	9. Auxiliary pulse 3 valid time	Initial value:10.0s, Range:0.0~999.9s (min)
	10. Auxiliary pulse 3 invalid time	Initial value:10.0s, Range:0.0~999.9s (min)
	11. Total execution time of auxiliary pulse 4	Total execution time of auxiliary pulse 4. If it's 0, it loops forever, Initial Value 0, range 0.0~999.9min (min)
	12. Auxiliary pulse 4 valid time	Initial value:10.0 min, Range:0.0~999.9min (min)
	13. Auxiliary pulse 4 invalid time	Initial value:10.0 min, Range:0.0~999.9min (min)
Over time Alarm	1.Fill, DICS overtime ON/OFF	Fill, DICS overtime ON/OFF When turn on, starts judging, initial value: OFF
	2.A coarse filling overtimer	Initial value 5.0, Range 0.0~99.9 (s)
	3.A medium filling overtimer	Initial value 5.0, Range 0.0~99.9 (s)
	4.A fine filling overtimer	Initial value 5.0, Range 0.0~99.9 (s)
	5.A DISC overtimer	Initial value 5.0, Range 0.0~99.9 (s)
	6.B coarse filling overtimer	Initial value 5.0, Range 0.0~99.9 (s)
	7.B medium filling overtimer	Initial value 5.0, Range 0.0~99.9 (s)
	8.B fine filling	Initial value 5.0, Range 0.0~99.9 (s)

	overtimer	
	9.B DISC overtimer	Initial value 5.0, Range 0.0~99.9 (s)

4.6 Motor Parameter

System maintenance parameters scale "Fill Gate Driver"," Clamper mode" and " DISC mode" are set to the motor, the following parameters can be seen.

◆ Right side is motor group, can swift

Motor parameter	Parameter	Description	
Filling parameters	1. Filling mode	0: Pneumatics mode, 1: Stepper motor mode, 2: Normal motor mode	
	2. Filling gate closed ready signal type.	0: Positive logic (If input is valid, gate closed ready). 1: Anti-logic (If input is invalid, gate closed ready).	
	3. Receipt ID relate to Motor ID	Set receipt ID relate to Motor ID	
	4. Filling gate closed overtime	Default value: 4.0, range: 0.0~99.9. (s)	
	5.A B step motor parameter	a. filling motor frequency	Default value: 12000, range: 1~50000. (Hz)
		b. Power-On Go 0 Pos. Freq	Power-On Go, Feeding motor returns to the origin at this frequency. Initial value: 2000 ; range: 1~50000 (Hz)
		c. Fine Flow pulse quantity	Default value: 1800, range: 1 ~ 60000.
		d. Medium Flow pulse quantity	Default value: 4300, range: 1 ~ 60000.
		e. Coarse Flow pulse quantity	Default value: 7750, range: 1~60000.
		f. A B Co-F, Me-F, Fi-F press	Test shortcut key, check the opening status of the controller, and is beneficial to quickly adjust the pulse number
g. Motor Start		A Motor Start Freq	

		Freq	Default value: 2000, range: 1~50000 (Hz) (this value can't bigger than A Motor Start Freq)	
		h. Motor ACC Time	A Motor ACC Time Default value: 100 , range: 0~9999 (ms)	
		i. Motor DEC Time	A Motor DEC Time Default value: 50 , range: 0~9999 (ms)	
		j. Filler Gate DIR Type	Filler Gate DIR Type 0 The direction signal output is invalid when the feeding door is opened: when the feeding door is opened, the rotation direction signal output of the feeding stepper motor is invalid, and the direction signal output is effective when the closing action is closed 1 The direction signal output is effective when the feeding door is opened: when the feeding door is opened, the rotation direction signal output of the feeding stepper motor is effective, and the direction signal output is invalid when the closing action is closed	
	6.A B motor parameter	a. Fi-Fill Gate Open Time	Fi-Fill Gate Open Time Default value: 0.2 , range: 0~99.99 (s)	
		b. Me-Fill Gate Open Time	Me-Fill Gate Open Time Default value: 0.4 , range: 0~99.99 (s)	
		c. Co-Fill Gate Open Time	Co-Fill Gate Open Time Default value: 0.8 , range: 0~99.99 (s)	
		d. A B Co-F, Me-F, Fi-F press	Test shortcut key, check the opening status of the controller, and is beneficial to quickly adjust the pulse number	
	Bag locked/unlocked parameters	1.A B step motor locked/unlocked parameters	a. locked/unlocked mode	Step motor
			b. Clamper Pos. Signal Type --(Pos. Signal)	0 If Input Signal "Filler Gate Closed Pos." Is ON, The Filler Gate Closed Firmly 1 If Input Signal "Filler Gate Closed Pos." Is OFF, The Filler Gate Closed Firmly
c. Clamper			Default value: 3.0 , range: 0.0~99.9 (s)	

		Open Overtime	
		d. Clamper Close Freq	Default value: 30000 , range: 1~50000 (Hz)
		e. Clamper Open Freq	Default value: 20000 , range: 1~50000 (Hz)
		f. Steps For Clamper Close	Default value: 12000 , range: 1~60000 (Hz)
		g. Power-On Go 0 Pos. Freq	Power-On Go, Feeding motor returns to the origin at this frequency. Initial value: 2000 ; range: 0~50000 (Hz)
		h. Motor Start Freq	Default value: 2000 range: 0~50000 (Hz) (this value can't bigger than A Motor Start Freq)
		i. Motor ACC Time	Default value: 200 , range: 0.0~9999 (ms)
		j. Motor DEC Time	Default value: 50 , range: 0.0~9999 (ms)
		k. Clamper DIR Signal Type	Motor direction signal state when bag clamping action of bag clamp 0The direction signal output is invalid when the bag is clamped: When the bag is clamped by the bag loosening mechanism, the rotation direction signal output of the stepper motor of the bag loosening mechanism is invalid, while the direction signal output is effective when the bag is clamped 1The direction signal output is effective when the bag is clamped: When the bag is clamped by the bag loosening mechanism, the rotation direction signal output of the stepper motor for the bag loosening mechanism is effective, but the direction signal output is invalid when the bag is loosening
		l. AB Clamper	Shortcut key for clamping clamper bag, which is used to detect the condition of clamping loose bag equipment

	2.A B Normal Motor(Two Pos. Signal)par ameter	a. Clamper Driver	Normal Motor(Two Pos. Signal)
		b. Clamper Pos. Signal Type --(Pos. Signal)	0 ON: If In Closed Pos.--(ON: If Closed) (If Input Signal "Filler Gate Closed Pos." Is ON, The Filler Gate Closed Firmly)。 1、 OFF: If In Closed Pos.--(OFF: If Closed) (If Input Signal "Filler Gate Closed Pos." Is OFF, The Filler Gate Closed Firmly)
		c. Clamper Close Overtime	Default value: 3.0 , range: 0.0~99.9 (s)
		d. Clamper Open Overtime	Default value: 3.0 , range: 0.0~99.9 (s)
		e.A B Clamper bag	Shortcut key for clamping unlock bag, which is used to detect the condition of clamping unlock bag equipment
	3.A B motor single limit lock/unloc k patameters	a. lock/unlock mode	motor single limit
		b. Clutch Limit Signal Type	0.signal valid limit (input valid, door close) 1.signal invalid limit (input invalid, door close)
		c. Bag Lock Overtime	Default value: 3.0 , range: 0.0~99.9 (s)
		d. Bag unlock Timer	Motor lock valid time Default value: 0.5 , range: 0~99.99 (s)
		e. A B Lock/ unlock	Lock/ unlock shortcut key, to test Lock/ unlock equipment situation
Discharg e Motor Paramet er (valid in Net Weigher mode)	1.A B DICS step motor parameter setting	a. Discharge Mode	Step motor
		b. DISC Gate Close OT	Default value: 3.0 range: 0.0~99.9 (s)
		c. DISC Gate Limit Signal Type	0 If Input Signal "Filler Gate Closed Pos." Is OFF, The Filler Gate Closed Firmly 1 If Input Signal "Filler Gate Closed Pos." Is OFF, The Filler Gate Closed Firmly
		d. DISC Gate Pos. Detect	Set to "off", the controller does not need to detect the unloading signal in place all the

			time, but only needs to detect once when starting feeding in each operation. Once the limit signal is detected, there is no need to detect the limit signal again. Set to "on", real-time detection of discharge motor is in the limit, if not the limit, shielding feeding output, and alarm prompt, until the limit is detected before resuming feeding.
		e.DISC Motor Open Frequency	Default value: 30000 , range: 1~50000 (Hz)
		f.DISC Motor Close Frequency	Default value: 20000 , range: 1~50000 (Hz)
		g.Discharge door open Steps	Default value: 12000 , range: 1~60000
		h. Power-On Go 0 Pos. Freq	Power-On Go, Feeding motor returns to the origin at this frequency. Initial value: 2000; range: 1~50000 (Hz)
		i. Motor Start Freq	Default value: 2000 range: 1~50000 (Hz) (this value can't bigger than A Motor Start Freq)
		j. Motor ACC Time	Default value: 200 , range: 0~9999 (ms)
		k. Motor DEC Time	Default value: 50 , range: 0~9999 (ms)
		l. DISC Gate DIR Signal Type	Discharging motor from close the door to open the motor direction signal state 0 direction signal output is invalid when unloading door opening: when unloading mechanism opens the door, the rotation direction signal output of unloading stepper motor is invalid, and the direction signal output is effective when closing the door 1. Direction signal output is effective when unloading and opening the door: when

			unloading mechanism opens the door, the output of rotation direction signal of unloading stepper motor is effective, and the output of direction signal is invalid when closing the door
		m.A B DISC Test	A. B DISC Test shortcut key
2.A B Normal Motor(One Pos. Signal) DISC parameter setting		a. DISC Gate Driver	Normal Motor(One Pos. Signal)
		b. DISC Gate Close Overtime	Default value: 3.0 , range: 0.0~99.9 (s)
		c. DISC Gate Pos. Signal Type	0、ON: If In Closed Pos.--(ON:If Closed) (input valid, door closed) 1、OFF: If In Closed Pos.--(OFF:If Closed) (input invalid, door closed)
		d. DISC Gate Open timer	A B DISC motor door opened signal output timer Default value: 1.00, range: 0.00~99.99 (s)
		f. DISC Gate Pos. Detect	Set to "off", the controller does not need to detect the unloading signal in place all the time, but only needs to detect once when starting feeding in each operation. Once the limit signal is detected, there is no need to detect the limit signal again.Set to "on", real-time detection of discharge motor is in the limit, if not the limit, shielding feeding output, and alarm prompt, until the limit is detected before resuming feeding.
		f. AB DISC Test	A. B DISC Test shortcut key
3.A B Normal Motor (Two Pos. Signal) parameter		a. DISC Gate Driver	Normal Motor(Two Pos. Signal)
		b.DISC Gate Close Overtime	Default value: 3.0 , range: 0.0~99.9 (s)
		c.DISC Gate Pos. Signal	0 ON: If In Closed Pos.--(ON:If Closed) (input valid, door closed)

setting	Type	1 OFF: If In Closed Pos.--(OFF:If Closed) (input invalid, door closed)
	d. DISC Gate Open Overtime	Default value: 3.0 , range: 0.0~99.9 (s)
	e. DISC Gate Pos. Detect	Set to "off", the controller does not need to detect the unloading signal in place all the time, but only needs to detect once when starting feeding in each operation. Once the limit signal is detected, there is no need to detect the limit signal again.Set to "on", real-time detection of discharge motor is in the limit, if not the limit, shielding feeding output, and alarm prompt, until the limit is detected before resuming feeding.
	f.A B DISC Test	A. B DISC Test shortcut key
4.AB Normal Motor Which Rotate One Circle To Discharge parameter setting	a. Discharge Mode	DISC Gate Driven By Normal Motor Which Rotate One Circle To Discharge
	b. DISC Gate Close Overtime	Default value: 3.0 , range: 0.0~99.9 (s)
	c. DISC Gate Pos. Signal Type	0 ON: If In Closed Pos.--(ON:If Closed) (input valid, door closed) 1 OFF: If In Closed Pos.--(OFF:If Closed) (input invalid, door closed)
	d. DISC Gate Pos. Detect	Set to "off", the controller does not need to detect the unloading signal in place all the time, but only needs to detect once when starting feeding in each operation. Once the limit signal is detected, there is no need to detect the limit signal again.Set to "on", real-time detection of discharge motor is in the limit, if not the limit, shielding feeding output, and alarm prompt, until the limit is detected before resuming feeding.
	e. DISC Gate Open time	A B DISC motor door opened signal output timer Default value: 1.00, range: 0.00~99.99 (s)

		f.A、 B DISC Test	A. B DISC Test shortcut key
--	--	---------------------	-----------------------------

4.7 ACUM

In the main interface, click **【ACUM】** to enter the interface. Under the "ACUM" parameter, the user can view the total accumulation/batch, formula accumulation, user accumulation, history record and carry out clearing, printing and other operations.

- ◆ Under **【ACUM and Batch】** interface, user can view the total accumulated value, accumulated times under the formula, total accumulation of the receipt and delivery and total accumulation of the system. set batch and the total quantity of delivery. If the serial port is set to print, click **【Data Processing】** to print the total ACUM, export the total ACUM by U-disk and clear the total ACUM and the batch.
- ◆ In **【total ACUM and Batch】** interface can set batch Net Weigher mode and the total quantity of delivery in Gross Weigher mode. After finish set batch number and the total quantity of delivery, controller in the main interface prompts "batch complete alarm or delivery alarm", wait for the user processing, when the "alarm" input signal valid, or press "clear alarm", controller will clear the alarm, or enter stop back to stop state also can clear alarm. (Note: if the total quantity of delivery set to 0, it is the receiving mode, otherwise it's dispatching mode)
- ◆ Under **【receipt ACUM】**, check all receipt ID's ACUM times and ACUM weight, press interface right side to swift receipt No. **1-8、9-16、17-24、25-32、33-40**, press **【Data Edit】** to clear all receipt ACUM, print all receipt ACUM, print current receipt ACUM, choose receipt print and export receipt ACUM by U-disk.
- ◆ Under **【receipt ACUM】** interface, delete receipt ACUM.
- ◆ Under **【User ACUM】** interface, to check all users' ACUM times and weight, press **【Data Edit】** to clear all users' ACUM, print all users' ACUM, print current users' ACUM, choose user to print and export receipt ACUM by U-disk etc.
- ◆ Under **【User ACUM】** interface, delete choosed users ACUM
- ◆ Under **【history record】** interface, can refer history record, click **【Data Edit】** can copy history record by U-disk, can delete history data.

4.8 I/O Module

GM9907-LD has equipped with 12 input ports and 16 output ports if with expansion board to connect with other devices. Click **【IO test】**, Check whether the output and input interfaces of the controller are normally connected with external devices.

The initialization definition of I/O as following, (Output ports **1-16** matches with OUT1~OUT16, Input ports 1-12 matches with IN1~IN12). Particularly, OUT12, OUT13, OUT14, OUT15, OUT16 is motor control output.

Net Weigher mode:

Output		Input	
OUT1	Run	IN1	Start up
OUT2	Stop	IN2	Emergency stop
OUT3	Scale A Coarse Flow	IN3	Scale A zero
OUT4	Scale A Medium Flow	IN4	Scale B zero
OUT5	Scale A Fine Flow	IN5	Scale A manual discharge
OUT6	Scale B Coarse Flow	IN6	Scale B manual discharge
OUT7	Scale B Medium Flow	IN7	Bag locked/unlocked request
OUT8	Scale B Fine Flow	IN8	Clear alarm
OUT9	Scale A value	IN9	Scale A manual Fine Flow
OUT10	Scale B value	IN10	Scale B manual Fine Flow
OUT11	Scale A discharge	IN11	Select recipes
OUT12	Scale B discharge	IN12	Pause
OUT13	Scale A Bag locked		
OUT14	Scale A Pat bag		
OUT15	Alarm		
OUT16	Over/Under		

Gross Weigher mode:

Output		Input	
OUT1	Run	IN1	Start up
OUT2	Stop	IN2	Emergency stop
OUT3	Scale A Coarse Flow	IN3	Slow stop
OUT4	Scale A Medium Flow	IN4	Scale A zero
OUT5	Scale A Fine Flow	IN5	Scale B zero
OUT6	Scale B Coarse Flow	IN6	Locked/unlocked request
OUT7	Scale B Medium Flow	IN7	Scale B bag locked/unlocked request
OUT8	Scale B Fine Flow	IN8	Scale A manual fill (level)
OUT9	Scale A value	IN9	Scale B Manual fill B (level)
OUT10	Scale B value	IN10	Scale A manual Fine Flow

OUT11	Scale A bag locked	IN11	Scale B manual Fine Flow
OUT12	Scale B bag locked	IN12	Clear alarm
OUT13	Scale A pat bag		
OUT14	Scale B pat bag		
OUT15	Alarm		
OUT16	Over/Under		

Bulk scale mode:

Output		Input	
OUT1	Run	IN1	Start up
OUT2	Stop	IN2	Emergency stop
OUT3	Scale A Coarse Flow	IN3	Slow stop
OUT4	Scale A Medium Flow	IN4	Scale A zero
OUT5	Scale A Fine Flow	IN5	Scale B zero
OUT6	Scale B Coarse Flow	IN6	Scale A manual discharge
OUT7	Scale B Medium Flow	IN7	Scale B manual discharge
OUT8	Scale B Fine Flow	IN8	Scale A manual fill (level)
OUT9	Scale A value	IN9	Scale B Manual fill B (level)
OUT10	Scale B value	IN10	Scale A manual Fine Flow
OUT11	Scale A discharge	IN11	Scale B manual Fine Flow
OUT12	Scale B discharge	IN12	Clear alarm
OUT13	Batch complete		
OUT14	Over/Under		
OUT15	Last Feed		
OUT16	Alarm		

4.8.1 Output port & input port definition

The output port and the input port can be defined according to the application content.

Modify the definition of input and output I/O module paracontrollers through the menu interface I/O module paracontrollers. Each I/O module corresponds to a code, as follows:

I/O module description

Output		
Code	Content	Explanation
00	Undfined	Undefined if output port is O0.

O1	Run	The output signal is defined valid in run status.
O2	Stop	The output signal is defined valid in stop status.
O3	Scale A Coarse Flow	To control large discharge opening of scale A filling system. If present weight value < target value – scale A Coarse Flow leading quantity in filling process, output signal is effective.
O4	Scale A Medium Flow	To control medium discharge opening of scale A filling system. If present weight value < target value – scale A Medium Flow leading quantity in filling process, output signal is effective.
O5	Scale A Fine Flow	To control slow discharge opening of scale A filling system. If present weight value < target value – scale A Fine Flow leading quantity in filling process, output signal is effective.
O6	Scale B Coarse Flow	To control large discharge opening of scale B filling system. If present weight value < target value – scale B Coarse Flow leading quantity in filling process, output signal is effective.
O7	Scale B Medium Flow	To control medium discharge opening of scale B filling system. If present weight value < target value – scale B Medium Flow leading quantity in filling process, output signal is effective.
O8	Scale B Fine Flow	To control slow discharge opening of scale B filling system. If present weight value < target value – scale B Fine Flow leading quantity in filling process, output signal is effective.
O9	Scale A bag locked	To control bag locked. Effective signal: bag locked. Ineffective signal: bag unlocked.
O10	Scale A value	Used to indicate scale A filling completed. During Fine Flow complete and material discharge (Net Weigher mode) or before pat bag (Gross Weigher), output signal is effective.
O11	Scale A discharge	To control hopper discharge gate. Output signal is effective when start discharging material from hopper A to bag.
O12	Scale B bag locked	To control bag locked system. Effective signal: bag locked. Ineffective signal: bag unlocked. Only effective in Gross Weigher mode.
O13	Scale B value	Used to indicate scale B filling completed. During Fine Flow complete and material discharge (Net Weigher mode) or before pat bag (Gross Weigher), output signal is effective.
O14	Scale B discharge	To control hopper discharge gate. Output signal is effective when start discharging material from hopper B to bag.
O15	Scale A pat	Used to control pat bag machine. The pulse width and times are

	bag	controllable.
O16	Scale B pat bag	Used to control pat bag machine. The pulse width and times are controllable. (Only for Gross Weigher mode.)
O17	Scale A cut material	Output is effective only during scale A filling period.
O18	Scale B cut material	Output is effective only during scale B filling period.
O19	Filling	To control the filling system. When the low material level input defined invalid, the output is effective. When the upper material level defined valid, the output is ineffective.
O20	Lack of material	When the low material level input defined invalid, the output is effective. When the upper material level defined valid, the output is ineffective.
O21	Scale A zero zone	Output port defined effective if scale A current weight is smaller than near-zero value.
O22	Scale B zero zone	Output port defined effective if scale B current weight is smaller than near-zero value.
O23	Alarm	Output port defined effective if Over/Under or batch times are over.
O24	Batch completed	Output port defined effective if batch completed.
O25	Over	Signal is effective when over.
O26	Under	Signal is effective when under.
O27	Over/Under	Signal is effective when over or under.
O28	Conveyor output	To control conveyor starts and stop in Gross Weigher mode. Effective signal: start. Ineffective signal: stop.
O29	Coding /Scale A coding	Output this signal when coding delay over and bag locked output is effective.
O30	Scale B coding	Output this signal when coding delay over and bag locked output is effective. Only for Gross Weigher mode.
O31	Scale A filling pulse output	When the filling mode is set to a stepping motor controlled fill gate ON/OFF, the output signal is a pulse signal fed to the scale A stepper motor driver to control the motor rotation. Note: This function can only be defined on one of the port

		to OUT12~OUT16
O32	Scale A filling direction	When the filling mode is set to a stepping motor controlled fill gate ON/OFF, the output signal is a direction signal fed to the scale A stepper motor driver to control the motor rotation. Note: This function can only be defined on one of the port to OUT1~OUT11.
O33	Scale B filling pulse output	When the filling mode is set to a stepping motor controlled fill gate ON/OFF, the output signal is a pulse signal fed to the scale B stepper motor driver to control the motor rotation. Note: This function can only be defined on one of the port to OUT12~OUT16.
O34	Scale B filling direction	When the filling mode is set to a stepping motor controlled fill gate ON/OFF, the output signal is a direction signal fed to the scale B stepper motor driver to control the motor rotation. Note: This function can only be defined on one of the port to OUT1~OUT11.
O35	Scale A bag lock/unlock pulse output	When the bag lock mode is set to a stepping motor controlled bag locked or bag unlocked, the output signal is a pulse signal fed to the scale A stepper motor driver to control the motor rotation. Note: This function can only be defined on one of the port to OUT12~OUT16.
O36	Scale A bag lock/unlock direction signal	When the bag lock mode is set to a stepping motor controlled bag locked or bag unlocked, the output signal is a direction signal fed to the scale A stepper motor driver to control the motor rotation. Note: This function can only be defined on one of the port to OUT1~OUT11.
O37	Scale B bag lock/unlock pulse output	When the bag lock mode is set to a stepping motor controlled bag locked or bag unlocked, the output signal is a pulse signal fed to the scale B stepper motor driver to control the motor rotation. (Only for Gross Weigher mode) Note: This function can only be defined on one of the port to OUT12~OUT16.
O38	Scale B bag lock/unlock direction	When the bag lock mode is set to a stepping motor controlled bag locked or bag unlocked, the output signal is a direction signal fed to the scale B stepper motor driver to control the

	signal	motor rotation. (Only for Gross Weigher mode) Note: This function can only be defined on one of the port to OUT1~OUT11.
O39	Scale A discharge pulse output	When the discharge mode is set to a stepping motor controlled discharging, the output signal is a pulse signal fed to the scale A stepper motor driver to control the motor rotation. Note: This function can only be defined on one of the port to OUT12~OUT16.
O40	Scale A discharge direction signal	When the discharge mode is set to a stepping motor controlled discharging, the output signal is a pulse signal fed to the scale A stepper motor driver to control the motor rotation. Note: This function can only be defined on one of the port to OUT1~OUT11.
O41	Scale B discharge pulse output	When the discharge mode is set to a stepping motor controlled discharging, the output signal is a pulse signal fed to the scale B stepper motor driver to control the motor rotation. Note: This function can only be defined on one of the port to OUT12~OUT16.
O42	Scale B discharge direction signal	When the discharge mode is set to a stepping motor controlled discharging, the output signal is a pulse signal fed to the scale B stepper motor driver to control the motor rotation. Note: This function can only be defined on one of the port to OUT1~OUT11.
O43	Scale A filling gate open	When the filling mode is set normal filling motor controlled the discharge gate, used to control large discharge gate opening of scale A. This signal is valid in filling process and the valid time can be set in the motor parameters.
O44	Scale B filling gate open	When the filling mode is set normal filling motor controlled the discharge gate, it used to control large discharge gate opening of scale B. This signal is valid in filling process and the valid time can be set in the motor parameters.
O45	Scale A filling gate closed	When the filling mode is set normal filling motor controlled the discharge gate used to control large discharge gate opening of scale A. This signal is valid in the end of Coarse/Medium/Fine Flow until filling limit is effective and the valid time can be set in the motor parameters.
O46	Scale B filling	When the filling mode is set normal filling motor controlled the

	gate closed	discharge gate used to control large discharge gate opening of scale B. This signal is valid in the end of Coarse/Medium/Fine Flow until filling limit is effective and the valid time can be set in the motor parameters.
O47	Scale A bag unlock	When bag locked mode is set normal motor control bag locked/unlocked. Effective signal: bag unlocked. Ineffective signal: bag locked.
O48	Scale B bag unlock	When bag locked mode is set normal motor control bag locked/unlocked. Effective signal: bag unlocked. Ineffective signal: bag locked.
O49	Scale A discharge gate closed	When the discharge mode is set to discharge with a common motor reversing controlling so as to control scale A discharge gate closing. Effective signal: discharge gate closed after discharging. Ineffective signal: stop closing.
O50	Scale B discharge gate closed	When the discharge mode is set to discharge with a common motor reversing controlling so as to control scale B discharge gate closing. Effective signal: discharge gate closed after discharging. Ineffective signal: stop closing.
O51	Sewing machine output	Sewing input valid, after the start delay of sewing ends, sewing output is valid.
O52	cutting machine output	Sewing output valid time ends, this output is valid, The valid time is the output valid time of the cutter
O53	Auxiliary pulse output 1	Auxiliary pulse 1 input valid, output pulse signal (valid time is auxiliary pulse 1 valid time, invalid time is auxiliary pulse 1 invalid time) ,stop output when the total execution time is up (If the total execution time is set to 0, the pulse output is always pressed) .
O54	Auxiliary pulse output 2	Auxiliary pulse 2 input valid, output pulse signal (valid time is auxiliary pulse 2 valid time, invalid time is auxiliary pulse 2 invalid time) ,stop output when the total execution time is up (If the total execution time is set to 0, the pulse output is always pressed) .
O55	Auxiliary pulse output 3	Auxiliary pulse 3 input valid, output pulse signal (valid time is auxiliary pulse 3 valid time, invalid time is auxiliary pulse 3 invalid time) ,stop output when the total execution time is up

		(If the total execution time is set to 0, the pulse output is always pressed) .
O56	Auxiliary pulse output 4	Auxiliary pulse 4 input valid, output pulse signal (valid time is auxiliary pulse 4 valid time, invalid time is auxiliary pulse 4 invalid time) ,stop output when the total execution time is up (If the total execution time is set to 0, the pulse output is always pressed) .
O57	A discharge patting output	It is used in the function of discharging patting. Under the running state, the function of starting patting under the condition of incomplete discharge can discharge the material completely.
O58	B discharge patting output	It is used in the function of discharging patting. Under the running state, the function of starting patting under the condition of incomplete discharge can discharge the material completely.
O59	Auxiliary logic Output 1	The output signal of the auxiliary logic output 1
O60	Auxiliary logic Output 2	The output signal of the Auxiliary logic output 2
O61	Auxiliary logic Output 3	The output signal of the Auxiliary logic output 3
O62	Auxiliary logic Output 4	The output signal of the Auxiliary logic output 4
O63	Auxiliary logic Output 5	The output signal of the Auxiliary logic output 5
O64	Auxiliary logic Output 6	The output signal of the Auxiliary logic output 6
O65	A Metering Hanger Up/Down	Metering Hanger Up/Down A output
O66	B Metering Hanger Up/Down	Metering Hanger Up/Down B output
O67	A Over /Under	When A exceeds or underranges, the output signal is defined as valid.
O68	B Over	When B exceeds or underranges, the output signal is defined as

	/Under	valid.
O69	Last Feed	When the signal is valid, the current is the last feed.
	Input	
I0	Undefined	Undefined if input port is 00
I1	Start	This signal is valid in running status. (Pulse input signal)
I2	Emergency stop	Return to stop state if signal is valid. (Pulse input signal)
I3	Slow stop	Finish current package and then return to stop status. (Pulse input signal)
I4	Scale A zero	Clear zero of scale A if signal is effective. (Pulse input signal)
I5	Scale B zero	Clear zero of scale B if signal is effective. (Pulse input signal)
I6	Bag locked/unlocked request	To control bag locked/unlocked. Bag locked when first input this signal; bag unlocked if input the signal again.
I7	Scale B bag locked/unlocked request	To control bag locked/unlocked. Scale B bag locked when first input this signal; scale B bag unlocked if input the signal again. Only for Gross Weigher.
I8	Clear accumulated	To clear accumulated weight and times. Accumulated recipes and users total are cleared at the same time.
I9	Scale A manual discharge	Used to manually clear the material in the hopper. Scale A discharge output is valid when input signal is valid, but invalid if again.
I10	Scale B manual discharge	Used to manually clear the material in the hopper. Scale B discharge output is valid when input signal is valid, but invalid if again.
I11	Scale A manual Fine Flow	Scale A slow output is valid when first input this signal, invalid if input again.
I12	Scale B manual Fine Flow	Scale B slow output is valid when first input this signal, invalid if input again.
I13	Scale A manual filling	Combination filling mode: Scale A Coarse /Medium /Fine Flow output is valid when first time input the signal. Invalid if input again. Solo filling mode: Scale A Coarse Flow output is valid when first time input the signal. Invalid if input again.

I14	Scale B manual filling	Combination filling mode: Scale B Coarse /Medium /Fine Flow output is valid when first time input the signal. Invalid if input again. Solo filling mode: Scale B Coarse Flow output is valid when first time input the signal. Invalid if input again.
I15	Select recipes	Only valid once. Recipe changes to next one which target value is not zero.
I16	Clear alarm	Clear alarm output. (Pulse input signal)
I17	Upper level	To connect upper level of the hopper. (Level input)
I18	Under level	To connect under level of the hopper. (Level input) Lack materials if invalid.Unlack materials if valid.
I19	Start/Stop (Level)	Enter running status if signal is valid, return to stop status if invalid. This is level signal.
I20	Start/Slow stop (Level)	Enter running status if signal is valid, return to stop status if invalid. This is level signal.
I21	Scale A manual discharge (Level)	Manually clear the materials in the hopper. Scale A discharge output is valid if input is effective.
I22	Scale B manual discharge (Level)	Manually clear the materials in the hopper. Scale B discharge output is valid if input is effective.
I23	Bag Locked	If the input is defined, valid means ready, invalid means not ready. Net Weigher mode: If bag locked in the running process, the controller will begin to discharge when bag locked ready. In discharge process, will not check the effectivity of signal. Gross Weigher mode: If bag locked in the running process, the controller will begin to fill when bag locked ready. In filling process, will not check the effectivity of signal. This is level input.
I24	Scale B bag locked ready	If input signal is valid, means bag locked ready and invalid means bag locked not ready. Gross Weigher mode: The controller starts to fill once detect bag locked ready is valid. In filling process, will not check the effectivity of signal. This is level input.

I25	Scale A discharge gate closed ready	If the signal is valid, means scale A gate closed ready. If discharge real time detection set ON and detect invalid signal, will shield filling output and alarm, the output controller light will be off. If detect valid signal and have to fill, it will clear alarm automatically and continue to fill. If discharge real time detection set OFF and discharge gate closed not ready, it will alarm. Once detect valid signal, starting to fill.
I26	Scale B discharge gate closed	If the signal is valid, means scale B gate closed ready. If discharge real time detection set ON and detect invalid signal, will shield filling output and alarm, the output controller light will be off. If detect valid signal and have to fill, it will clear alarm automatically and continue to fill. If discharge real time detection set OFF and discharge gate closed not ready, it will alarm. Once detect valid signal, starting to fill.
I27	Scale A manual Fine Flow (level)	Effective signal: Scale A manual Fine Flow output is valid. Ineffective signal: Scale A manual Fine Flow output is invalid.
I28	Scale B manual Fine Flow (level)	Effective signal: Scale B manual Fine Flow output is valid. Ineffective signal: Scale B manual Fine Flow output is invalid.
I29	Scale A manual fill (level)	Combination filling mode: Scale A Coarse/Medium/Fine Flow output are valid if effective input. Solo filling mode: Scale A Coarse Flow output is valid if effective input.
I30	Scale B manual fill (level)	Combination filling mode: Scale B Coarse/Medium/Fine Flow output are valid if effective input. Solo filling mode: Scale B Coarse Flow output is valid if effective input.
I31	Scale A fill gate closed ready	When stepping motor controls filling gate ON/OFF, it is limit digit input signal for scale A filling gate closed ready. When normal motor controls filling gate ON/OFF, it is limit digit input signal for scale A filling gate closed ready. (Note: this signal is determined by the digit signal type. Positive logic: The filling gate is closed if signal is valid. Negative logic: The filling gate is closed if signal is invalid.
I32	Scale B fill gate closed	When stepping motor controls filling gate ON/OFF, it is limit digit input signal for scale B filling gate closed ready.

	ready	When normal motor controls filling gate ON/OFF, it is limit digit input signal for scale B filling gate closed ready. (Note: this signal is determined by the digit signal type. Positive logic: The filling gate is closed if signal is valid. Negative logic: The filling gate is closed if signal is invalid.)
I33	Scale A bag unlocked ready	It is a limit input signal of bag unlocked ready when stepping motor and motor double limit digit controlling bag locked/unlocked. (Note: this signal is determined by the digit signal type. Positive logic: Bag unlocked ready if signal is valid. Negative logic: Bag unlocked ready if signal is invalid.)
I34	Scale B bag unlocked ready	It is a limit input signal of bag unlocked ready when stepping motor and motor double limit digit controlling bag locked/unlocked. (Note: this signal is determined by the digit signal type. Positive logic: Bag unlocked ready if signal is valid. Negative logic: Bag unlocked ready if signal is invalid.)
I35	Scale A discharge gate opened ready	When material discharged is controlled by normal motor reversible double limit, it is a signal of discharge gate opening ready and discharge gate open.
I36	Scale B discharge gate opened ready	When material discharged is controlled by normal motor reversible double limit, it is a signal of discharge gate opening ready and discharge gate open.
I37	Sewing machine input	When this I/O Module input is valid, start sewing valid output (pulse signal).
I38	Sewing machine Emergency Stop	When this I/O Module input is valid, sewing stop output (level signal).
I39	Auxiliary pulse 1	The input is valid, the auxiliary pulse 1 output is valid, the second input is valid, and the auxiliary pulse 1 output is invalid
I40	Auxiliary pulse 2	The input is valid, the auxiliary pulse 2 output is valid, the second input is valid, and the auxiliary pulse 2 output is invalid
I41	Auxiliary pulse 3	The input is valid, the auxiliary pulse 3 output is valid, the second input is valid, and the auxiliary pulse 3 output is

		invalid
I42	Auxiliary pulse 4	The input is valid, the auxiliary pulse 4 output is valid, the second input is valid, and the auxiliary pulse 4 output is invalid
I43	Auxiliary logic input 1	Custom trigger input signal for auxiliary logic 1.
I44	Auxiliary logic input 2	Custom trigger input signal for auxiliary logic 2.
I45	Auxiliary logic input 3	Custom trigger input signal for auxiliary logic 3.
I46	Auxiliary logic input 4	Custom trigger input signal for auxiliary logic 4.
I47	Auxiliary logic input 5	Custom trigger input signal for auxiliary logic 5.
I48	Auxiliary logic input 6	Custom trigger input signal for auxiliary logic 6.
I49	Filling allow input	Filling allowed input: if filling allowed input is defined in the I/O Module, judge whether filling allowed input is effective before filling flow. If it is effective, the filling flow will be started. If it is not, wait.
I50	DISC allow input	DISC allow input is only for Net Weigher mode, if Disc allowed input is defined in the I/O Module, judge whether Disc allowed input is effective after waiting. If it is effective, the Disc flow will be started. If it is not, wait.
I51	B Filling allow input	Filling allowed input: if B filling allowed input is defined in the I/O Module, judge whether B filling allowed input is effective before filling flow. If it is effective, the filling flow will be started. If it is not, wait.
I52	B DISC allow input	DISC allow input is only for Net Weigher mode, if B Disc allowed input is defined in the I/O Module, judge whether B Disc allowed input is effective after waiting. If it is effective, the Disc flow will be started. If it is not, wait.
I53	A Metering Hanger Up/Down	When this input is valid, A Metering hanger upward is valid
I54	B Metering	When this input is valid, B Metering hanger upward is valid

	Hanger Up/Down	
--	-------------------	--

Note: DISC allow description: When working mode is Net Weigher AB dual scales, dual hopper dual clip bag AB individual, dual hopper dual clip bag AB comb, Gross Weigher AB individual, Gross Weigher AB comb, if define filling/disc flow allow input, then works as follow.

When scale A undefine filling /disc allow, scale B define filling/disc allow. Scale A filling/disc is not controlled, run as formal process, scale B need filling/disc allow signal to control.

When scale A define filling/disc allow, scale B undefined filling/disc allow. Scale B filling/disc uncontrolled run as normal process, scale A need filling/disc allow signal to control.

When dual AB both define filling/disc allow, scale A and scale B need separate filling/dics allow signal to control.

4.9 Host mode

Host mode can communicate with slave to send commands. When using host mode, pay attention to the following points:

- ◆ The communication parameters of serial port 2 are fixed in host mode. Only when the communication mode is Modbus-RTU mode can host mode be used, otherwise it is prohibited.
- ◆ In host mode, the starting address is fixed to 1.
- ◆ Successful write will return successful send; Write data failure returns send failure; when there is no return for a long time, the return send timeout.
- ◆ In host mode, changing the high and low bytes of serial port 2 will change the storage order of the data sent to the slave. The high and low bits correspond to each other and can be used when the data length is double word.

Host mode	1. Communicatio n ID	Initial value: 1 ; 1 ~99 optional.
	2. data length	Initial value: Single byte. Single/double byte is optional
	3. Initial address	Initial value: 1 ; 1~65535 optional, start at 0X0001 by default.
	4. Setting parameter	Initial value: 0 ; 0 ~ 999999 optional.

5. Function Description

5.1 Setting the operating mode

1. Operating parameter scale structure is Net Weigher.

Set the following 15 kinds of ways:

1) Operating mode chose dual weigher Net Weigher

1.1) AB target value set off separately, set target value $>$ single hopper weighing limit, single hopper target value automatically converted.

1.2) AB target value set off separately, set target value \leq single hopper weighing limit, single hopper target value is target value.

1.3) AB target value set on separately, set A/Btarget \leq single hopper weighing limit.

2) Operating mode chose A weigher Net Weigher

2.1) AB target value set off separately, set target value $>$ single hopper weighing limit, single hopper target value automatically converted.

2.2) AB target value set off separately, set target value \leq single hopper weighing limit, single hopper target value is target value.

2.3) AB target value set on separately, set A target value \leq single hopper weighing limit.

3) Operating mode chose B weigher Net Weigher

3.1) AB target value set off separately, set target value $>$ single hopper weighing limit, single hopper target value automatically converted.

3.2) AB target value set off separately, set target value \leq single hopper weighing limit, single hopper target value is target value.

3.3) AB target value set on separately, set B target value \leq single hopper weighing limit.

4) Operating mode chose AB weigher Net Weigher

4.1) AB target value set off separately, set target value $>$ single hopper weighing limit, single hopper target value automatically converted.

4.2) AB target value set off separately, set target value \leq single hopper weighing limit, single hopper target value is target value.

4.3) AB target value set on separately, set AB target value \leq single hopper weighing limit.

5) Operating mode chose AB comb weigher Net Weigher

5.1) AB target value set off separately, set target value $>$ single hopper weighing limit, single hopper target value automatically converted.

5.2) AB target value set off separately, set target value \leq single hopper weighing limit, single hopper target value is target value.

5.3) AB target value set on separately, set AB target value \leq single hopper weighing limit.

Note: Net Weigher mode normally choose dual scale operating mode, the rest mode is failure mode.

2. Operating parameter scale structure is Gross Weigher.

Set the following four kinds of ways:

1) Gross Weigher dual scale operate individually mode: operating mode choose Gross

Weigher AB individual, AB target value set off individually, AB both using target value.

- 2) Gross Weigher dual scale operate individually mode: operating mode choose Gross Weigher AB individual, AB target value set on individually, AB using A/B target value separately.
- 3) Gross Weigher dual scale comb mode: operating mode choose AB Comb Gross Weigher, AB target value set off individually, AB both using target value.
- 4) Gross Weigher dual scale comb mode.: operating mode choose AB Comb, AB target value set on individually, AB using A/B target value separately.

Note: Controller default: Net Weigher AB target value is off.

5.2 Batch

Batch is used for packaging frequency reminder, when automatic operation is completed and set batch is reached, controller show batch reach, alarm and shutdown, waiting for user to process, batch reach and alarm is valid, user can press **【Clear Alarm】** Key or to "clear alarm" input signal is valid, controller clears alarm. The batch number is zero, and then batch number judgment is not operated.

Batch range is 0~9999.initial default value is 0 (No batch judgment) .

5.3 Filling Level Control

Depending on application difference, controller material tank's level gage mounting has two ways: Dual Supplement (Supplement Full, Supplement Empty), Single Supplement (Supplement Empty) and no filling level control.

5.3.1 Dual Supplement

Supplement full and Supplement NotEmpty are defined, corresponding to the case of dual level. In this situation, controller include filling control function, which control principle is: when Supplement full and Supplement NotEmpty input are invalid, controller filling output is valid, when Supplement full input is valid, filling output is invalid. Meanwhile, before filling (coarse flow, medium flow, fine flow), controller detect supplement empty if is valid, if invalid wait for signal, only this signal is valid then start filling process. In the filling procession, controller do not detect Supplement NotEmpty signal if is valid.

5.3.2 Single Supplement

Supplement NotEmpty is defined; supplement full is undefined, corresponding to the case of signal level, controller do not contain filling control function, detect supplement empty before filling, waiting for the signal when Supplement NotEmpty is invalid, only the signal is valid, then start filling process. controller do not detect Supplement NotEmpty signal if is valid when filling.

Supplement NotEmpty and supplement full are undefined, corresponding to the no material level editor. Controller do not control filling, do not detect Supplement NotEmpty signal if is valid when filling.

5.4 Quick Setup

In stop mode, quick modify recipe data stored in real time.

Modification of runtime data, a zero value is stored in real-time, other parameters after exiting the quick setup interface, automatic updates are operated (combined mode need to unlock bags , start to run the next scale then target value is updated) when the next scale started.

Finished modifying the recipe parameters when running, but not yet reached the next scale update, the emergency stop signal is input into the controller, controller in stop mode, recipe update immediately.

Modbus the recipe value and advance value can be modified when communicating.

5.5 U disk update software

5.5.1 Foreground update process

1.	Plug the USB drive containing the upgrade kit "tpcbackup" into the controller
2.	Click "Yes" to enter the system setting interface and start the comprehensive feature pack. Click "No" to exit. "Click" Yes "to pop up the" User Project Update Button ".
3.	After clicking the "User Project Update" button, select the project to download
4.	After download will restart automatically

5.5.2 Background update process

1.	Insert U disk to computer, creat new folder "GM9907 - LD" in the U dish;
2.	Save " GM9907-L-Upload.gm " to folder " GM9907-LD "
3.	Plug the USB disk into the controller, switch to the system administrator authority, to the System Maintenance - Software Upgrade interface, long press the blank in the lower right corner of 5S, and the " Update " button pops up, jump to the upgrade interface, click " Update ", click " Update " again, and the words " Updating " appear, controller is upgrading the background
4.	When the progress bar is finished, the upgrade will be successful after the countdown of 10s and the login interface will be switched to

5.6 U disk update boot interface

Steps as follow:

1.	Save the image file (resolution 800*480, format.bmp) into the root directory of U disk containing the project package (tpcbackup)(Note: the upgrade kit "tpcbackup" is different from this tpcbackup)
2.	Insert U disk to controller
3.	Controller pops up the display of 【USB disk kit】, and select“Update startup bitmap”.
4.	Enter the LOGO selection interface, select the picture to be upgraded, and click OK. It will prompt you to restart after successful bitmap update

5.7 Sewing control

The function of sewing machine involves I/O Module: “Sewing ON ", " Cutter Work ", " Sewing Start ", " Sewing Stop ".

Mode 1 (Sewing ON Timer not 0): Sewing Start (Pulse) signal valid, sewing working process begin, first start is Sewing Start Delay Timer, delay timer finish, sewing starts, then sewing on, Sewing ON Timer finish, starts Sewing Stop Delay, meanwhile starts Cutter Start Delay Timer, Sewing Stop Delay finish sewing output invalid, when cutter Start Delay Timer finish, cutter starts to work, work time is Cutter Work Timer, Cutter Work Timer finish, cutter stop working. Process is finish.

Mode 2 (Sewing ON Timer is 0): Sewing Start (Level Signal) signal is valid, starts Sewing Start Delay Timer, timer finish re-test Sewing Start signal if is valid, if invalid, Sewing ON signal is off, delay timer finish, sewing starts to work, continuous output time is Sewing ON Timer, when Sewing ON Timer is finish, starts Sewing Stop Delay timer, meanwhile starts Cutter Start Delay Timer. Sewing continue work, continuous output time is Sewing Stop Delay timer. Cutter Start Delay timer, when Cutter Start Delay time is finish, cutter starts to work, work time is cutter work timer, cutter work timer finish, cutter stop working.

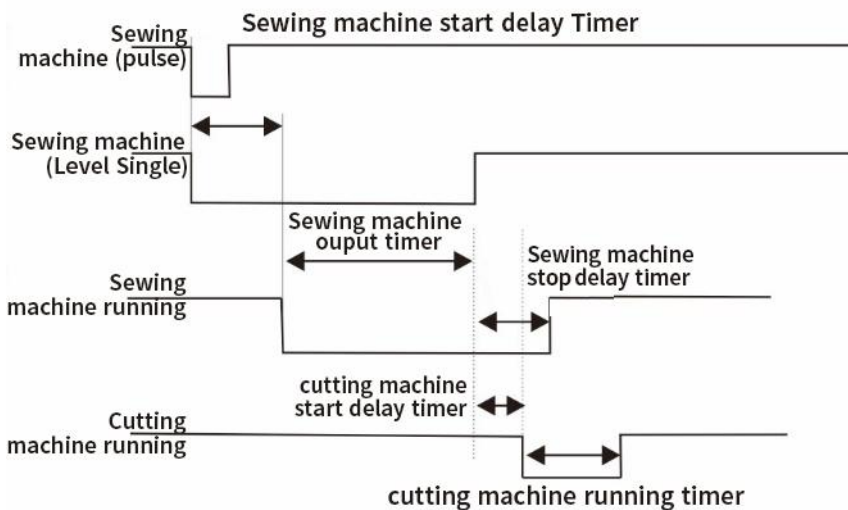

5.8 Discharge patting control

Take Scale A discharge patting function for example: turn on discharge patting, in the operate state; timing starts when discharge begins, when discharging time exceeds the set discharging valid time, the weight of the material in the hopper has not returned to the zero zone, at this time discharge patting A output is valid (this output is pulse, valid time is discharge patting valid time, invalid time is discharge patting invalid time). When discharge patting time is reach, the weight of the hopper is not lower than zero at this time, controller output discharging timeout alarm, back to stop state. When the discharge times of patting is not reached or just finished. When the weight of material in the hopper is less than zero zone value, start discharge delay time, delay to this weighing ends.

5.9 Alarm function of filling and discharge overtime

Take scale A coarse flow filling overtime function for example: turn on filling and discharge overtime judge fuction, in the operate state, when Scale A starts coarse flow, starts timing, if scale A coarse flow time exceeds scale A coarse flow timeout time, controller output alarm, and back to stop state.

Take scale A discharge overtime function for example: turn on filling and discharge timeout judge function, in the operate state, when Scale A begins discharge, starts timing, if scale A discharge time exceeds scale A discharge timeout time, controller output alarm, and back to stop state.

5.10 Auxiliary pulse function

When controller in stop or operate state, I/O module input I39 (auxiliary pulse 1) is valid, then I/O Module output O53 (auxiliary pulse output 1) starts output, the valid time of continuous output is the valid time of auxiliary pulse 1 output, when time is up, stop output, after waiting for the invalid output time of auxiliary pulse 1 to arrive, the output starts again. Stop output until the total operation time of auxiliary pulse 1 reaches, and input I39 auxiliary pulse 1 is invalid. If auxiliary pulse 1 operation total time is set to 0, then the auxiliary pulse output process will continue to loop.

If auxiliary pulse operate process I/O module input I39 (auxiliary pulse 1) is valid, then auxiliary pulse 1 output (O53) will stop output.

5.11 Adaptive function

The adaptive function omits the steps of manual adjustment and can automatically adjust the filling speed and accuracy. After this function is process, it will automatically adjust the parameters of Coarse Flow Remains, Medium Flow Remains, Fine Flow Remains, COMP. Inhibit Timer(Co-F), COMP. Inhibit Timer(Me-F), COMP. Inhibit Timer(Fi-F) and so on in the process of filling, so as to achieve the optimal filling speed and accuracy. (after the adaptive parameter update ON/OFF is turned on, controller will display the current modified parameters in real time.)

Adaptive use:

Mode 1: set all the advance parameters (set the advance parameters, only roughly accurate), controller will be on the basis of the current advance, according to the changes in the warehouse pressure, etc., constantly modify the advance parameters, to achieve an optimal state.(this method is recommended)

Mode 2: if all the current remains are 0, when the first scale starts, controller will control the scale body and automatically find the corresponding remains.The first scale may be inaccurate, but after a few times of work, will find the corresponding accurate amount to reach an optimal state.

Note:

1. It is suggested to add material level ON/OFF to ensure the stability of material flow. Controller also has the function of judging whether the material flow is stable, but not all of them can be judged successfully.

2. If drop correction and adaptive function are opened at the same time, the drop correction function will be forcibly closed.

3. In the normal filling process, if there is an occasional overshoot, it can be considered to increase the adaptive level.

5.12 Hanger up control function

Gross Weigher mode, start the controller, controller up signal output, wait for after the up delay, began to peel (net weight), if the bag is enabled, the up signals with pat bags for output (pat bag when output is invalid, up, pat bags output is valid, the upside is invalid), setting value after the bag is the same. When the hanger up signal is invalid, the hanger up delay starts. When the hanger up delay ends, the bag starts to unlock.

When the controller is in the stop state, when the hanger up signal is valid, the hanger up; when the up signal is invalid, the hanger down.

6. Serial port communication

GM9907-LD It provides two serial port, it provides two serial communication interface, and serial port 1 and 2 can be selected in a continuous manner, Modbus mode and printed three functions. controller for the first serial port is RS-232, the second is RS-485.

6.1 Printing method

When serial port parameter port 1 or 2 choose print mode, corresponding to the serial port can be connected to a serial printer to print the contents accumulated by implementation-dependent.

Print mode communication parameters refer to serial port parameters, need to note:

- 1) **Baud Rate**——parameters need to consist with connected printer.
- 2) **Communication format**——parameters need to consist with connected printer.

Note: When printing options for Chinese language, can not use the data bits to 7 formats, otherwise there will be printing error.

- 3) **Print format**——Peripheral parameters can be setted by print format of 24 or 32 formats. Besides by peripherals parameters printing language is Chinese or English.

6.1.1 Auto Print

In printing mode, the parameters of the peripheral automatically print ON/OFF is set to open. So after each weighing is completed, controller automatically prints the weighing result of this times.

Net Weigher and Gross Weigher scale mode, the format as follow:

English 24 print formats are as follows:

Packing list
 Unit: kg
 Recipe Number: 20
 The total cumulative number of results

```
-----
1          5.50
2          5.50
```

English 32 print formats are as follows:

Packing list
 Unit: kg
 Recipe Number: 20

The total cumulative times	target value	result
3	5.60	5.50
4	6.00	5.80

In bulk scale mode, the format as follow:

English 24 print formats are as follows:

&

Receipt and delivery list

Scale No.: 1 Recipe Number: 1

Total: 0.00

Time: 2022/01/21 13:30

Unit: kg

Cumulative number	Results
12	13.58
13	13.58
14	13.58
15	13.58

English 32 print formats are as follows:

&

Receipt and delivery list

Scale No.: 1 Recipe Number: 20

Total: 0.00

Time: 2022/01/21 13:31

Unit: kg

Cumulative times	Results	Total receipt/delivery
21	13.58	240.40
22	13.58	253.98
23	13.58	267.56

6.1.2 Total cumulative print

In printing mode, stop, press shortcut key, and enter ACUM and Batch interface, press Print total ACUM.

Net Weigher and Gross Weigher scale mode, the format as follow:

English 24 print formats are as follows:

The total cumulative report
Time: 2018/6/19 13:28
Unit: kg

The total cumulative number of times: 18
Total cumulative weight: 84.16

English 32 print formats are as follows:

The total cumulative report
Time: 2018/6/19 13:36
Unit: kg

The total cumulative number of times: 24
Total cumulative weight: 129.40

In bulk scale mode, the format as follow:

English 24 print formats are as follows:

The total cumulative report
Scale No.: 1 Recipe Number: 1
Total: 0.00
Time: 2022/01/21 13:30

Flow rate:257.30t/h
Total receipt/delivery: 471.26kg
Total accumulation: 471.26kg

English 32 print formats are as follows:

Scale No.: 1 Recipe Number: 1
Total: 0.00
Time: 2022/01/21 13:31

Flow rate:257.30t/h
Total receipt/delivery: 471.26kg
Total accumulation: 471.26kg

6.1.3 Cumulative print the recipe

In printing mode, stop, press shortcut key, and enter ACUM and Batch interface. Press selected recipe cumulative print, press \sim or \wedge Key to ON/OFF the selected recipe.

Press Print All recipe ACUM, to print all formulations (1 to 40) is accumulated, the meter will automatically skip the target value 0 is not printed formulations. Format is as follows:

English 24 print formats are as follows:

```

Recipe cumulative report
Time: 2018/6/19 13:29
Unit: kg
-----
Recipe Number:                20
The cumulative number of recipes: 18
Recipe cumulative weight:      84.16
-----
    
```

English 32 print formats are as follows:

```

Recipe cumulative report
Time: 2018/6/19 13:36
Unit: kg
-----
Recipe Number:                20
The cumulative number of recipes: 24
Recipe cumulative weight:      129.40
-----
    
```

6.1.4 User cumulative print

In printing mode, stop, press shortcut key, and enter ACUM and Batch interface. press>User interface switch to the total, press printkey, print the selected user has been accumulated in \sim or \wedge Key to switch the selected user.

Press Print All user ACUM, to print all users (1 to 9) is accumulated, the controller will automatically skip the user's cumulative user 0 is not printed. Format is as follows:

English 24 print formats are as follows:

```

Cumulative User Report
Time: 2018/6/19 13:29
Unit: kg
-----
User Number:                  9
User cumulative number:       16
User cumulative weight:       72.26
    
```

English 32 print formats are as follows:

Cumulative User Report

Time: 2018/6/19 13:37

Unit: kg

User Number: 9
 The cumulative number of users: 22
 User cumulative weight: 117.50

6.2 Continuous mode

A continuous manner, the meter sends the meter serial port results in outward selected serial communication port 1 or 2 selected

6.2.1 Continuous mode data frame format is as follows:

STX	Scale No.	R	T	SP	SP	The cumulative number of	,	Cumulative weight	CRC	CR	LF
------------	-----------	----------	----------	-----------	-----------	--------------------------	---	-------------------	------------	-----------	-----------

Among them:

R —— **52H**

T —— **54H**

SP —— **20H**

The cumulative number of --9 byte 000000000 to 999999999

Cumulative weight --10 bytes containing the decimal point

Controller such as issue data (in hexadecimal form):

02 30 31 52 54 20 20 20 20 20 20 20 20 20 20 20 20 20 20 20 20 20 31 30 30 2C 20 20 20 20 20 30 2E 35 30 30 30 32 39 0D 0A

It said: # 1 scale, the current cumulative number of 100 times, the cumulative weight of 0.5000.

6.3 Modbus-RTU protocol

In the serial communication port 1 or 2 is selected Modbus-RTU mode.

6.3.1 Function code and abnormal code

◆ Controller function codes supported:

function code	name	Explanation
03	Read register	Up to 125 single read registers
06	Write Single Register	

16	Write Multiple Registers	The controller supports a write command is only double register, the address must be aligned, not allowed writing only a portion of the double register is written, allowing read-only portion read out.
01	Read coil	Note that this is the bit length units
05	Write coil	

Note: The controller only supports MODBUS function code above, will not be the controller response function code to other controllers.

◆ MODBUS exception code in response to

Code	name	meaning
02	Illegal Data Address	For this controller, the data representing the address of the error code is an address not allowed.
03	Illegal data value	And writing the data portion of the permitted range.
04	Slave failure	When the controller is attempting to perform the requested operation, resulting in unrecoverable error.
07	Unsuccessful programming request	For controllers, the the received command can not be executed under the current conditions.

6.3.2 MODBUS transmission mode

The transmission mode is MODBUS RTU mode.

When communication with the RTU mode, information of each 8-bit byte is divided into two 4-bit transmission character hexadecimal.

Data Format: **8** Data bits, **1Stop** bit, even parity (**8-E-1**)

8 Data bits, **1Stop** bits, no parity (**8-N-1**)

Baud rate: **9600/19200/38400/57600/115200**(Choose one)

Code: RTU

6.3.3 MODBUS address assignment

Protocol address	PLC address	Meaning	Description	
Read only register				
0000-0001	40001-40002	Scale A present weight	The weight of scale A on the controller is shown	
0002-0003	40003-40004	Scale A present weight state (changes to the high and low bytes do not affect the status bit)	.0	Unstable weight: 0. Stable: 1.
			.1	Non-zero:0. Zero: 1.
			.2	Symbol of present weight: +/- Positive: 0. Negative: 1.
			.3	Overflow
			.4	Positive overflow
			.5	Negative overflow
			.6	Load cell positive overflow
			.7	Load cell negative overflow
.8	Stable millivolt: 1. Unstable: 0.			

			.9~31	Reserve
0004-0005	40005-40006	Scale B present weight	Referring to Scale B present weight state	
0006	40007	Scale B present weight state (changes to the high and low bytes do not affect the status bit)	.0	Unstable weight: 0. Stable: 1.
			.1	Non-zero:0. Zero: 1.
			.2	Symbol of present weight: +/- Positive: 0. Negative: 1.
			.3	Overflow
			.4	Positive overflow
			.5	Negative overflow
			.6	Load cell positive overflow
			.7	Load cell negative overflow
			.8	Stable millivolt: 1. Unstable: 0.
			.9~31	Reserve
0008-0009	40009-40010	Scale A & Scale B control state (changes to the high and low bytes do not affect the status bit)	.0	0: Stop. 1: Run.
			.1	Alarm
			.2	Batch completed
			.3	Bag locked
			.4	Upper level
			.5	Under Level
			.6	Filling material
			.7	Lack material
			.8	Pat bag
			.9	Conveyor output (Gross Weigher)
			.10	Coding output
			.11	Sewing machine output
			.12	cutting machine output
			.13	Auxiliary pulse 1
			.14	Auxiliary pulse 2
			.15	Auxiliary pulse 3
			.16	Auxiliary pulse 4
			.17	Relay output 1
			.18	Relay output 2
			.19	Relay output 3
			.20	Relay output 4
			.21	Relay output 5
			.22	Relay output 6
			.23	In the suspension
			.24	Metering Hanger Up A
			.25	Metering Hanger Up B
			.26	Last Feed
.27~31	Reserve			
0010-0011	40011-40012	Scale A control state (changes to	.0	Before scale A filling
			.1	Scale A Coarse Flow
			.2	Scale A Medium Flow

		the high and low bytes do not affect the status bit)	.3	Scale A Fine Flow
			.4	Scale A value
			.5	Scale A discharge
			.6	Scale A zero zone
			.7	Scale A overlimit
			.8	Scale A underlimit
			.9	Scale A qualified
			.10	Scale A over/under pause
			.11	Scale A bag locked (Gross Weigher)
			.12	Scale A pat bag
			.13	Scale A coding output
			.14	Gross weight: 0. Net weight: 1.
			.15	A Discharge patting
			.16~31	Reserve
0012-0013	40013-40014	Scale B control state (changes to the high and low bytes do not affect the status bit) Referring to Scale A control state		
0014-0015	40015-40016	Total accumulated weight (0~99999999)		
0016-0017	40017-40018	Total accumulated bags (0~99999999)		
0018-0019	40019-40020	The current recipe cumulative weight (0~99999999)		
0020-0021	40021-40022	The current recipe cumulative bags (0~99999999)		
0022-0023	40023-40024	User accumulated weight (0~99999999)		
0024-0025	40025-40026	User cumulative bags (0~99999999)		
0026-0027	40027-40028	Scale A previous weight value		
0028-0029	40029-40030	Scale B previous weight value		
0030	40031	Scale A alarm information (changes to the high and low bytes do not affect the status bit)	0.	No alarm
			1.	Unable to start for unreasonable recipe setting.
			2.	Unable to start as the maximum capacity of the hopper is 0.
			3.	Weight value exceeds zero range when zeroing;
			4.	Weighing value is unstable when zeroing.
			5.	Over/Under alarm.
			6.	The target value of single scale can not be set as 0 or the full capacity is too large.
			7.	The target value is bigger than maximum capacity value.
			8.	Weight value or load cell is overlimit when start.
			9.	Discharge gate is sepearated from limit digit.
			10.	Not bag locked.
			11.	Zeroing in the process of running.
0031	40032	Scale B alarm information (changes to the high and low bytes do not affect the status bit)		

			12. Zeroing over range in the process of running. 13. Zeroing is not unstable in the process of running. 14. The motor parameters is unreasonable (normal motor) 15. Reserved
0032-0033	40033-40034	Normal alarm information (Need to be manually cleared) (changes to the high and low bytes do not affect the status bit)	0- No alarm; 1- Batch completed; 2- Scale A Over/Under pause 3- Scale B Over/Under pause 4- Motor filling gate of scale A closed over time alarm 5- Motor filling gate of scale B closed over time alarm 6- Scale A bag locked over time alarm 7- Scale B bag locked over time alarm 8- Scale A bag unlocked over time alarm 9- Scale B bag unlocked over time alarm 10- Scale A discharge gate closed over time alarm 11- Scale B discharge gate closed over time alarm 12- Scale A discharge gate opened over time alarm 13- Scale B discharge gate opened over time alarm 14- Scale A fill gate not closed in place alarm. 15- Scale B fill gate not closed in place alarm. 16- Scale A discharge gate not closed in place alarm. 17- Scale B discharge gate not closed in place alarm. 18- The communication is abnormal of main board and addition board. 19- Scale A coarse filling overtime alarm 20- Scale B coarse filling overtime alarm 21- Scale A medium filling overtime alarm 22- Scale B medium filling overtime alarm 23- Scale A fine filling overtime alarm 24- Scale B fine filling overtime alarm 25- Scale A discharge overtime alarm. 26- Scale B discharge overtime alarm 27- Scale A discharge patting overtime alarm 28- Scale B discharge patting overtime alarm
0034	40035	Scale A & Scale B	0- No alarm 1- Maximum range is too small

		calibration alarm(changes to the high and low bytes do not affect the status bit)	2- Maximum range is too large 3- Zero voltage is too high 4- Zero voltage is too low 5- Unstable zero point 6- Gain voltage is too large 7- Gain voltage is too small 8- Scale platform is unstable 9- Weight value input is error 10- Resolution is low after calibration. 11- Manual Coarse Flow then Manual Discharge(material calibrate alarm) 12:Reserved
0035	40036	A Previous scale Coarse Flow Timer	Unit: S
0036	40037	A Previous scale Medium Flow	Unit: S
0037	40038	A Previous scale Fine Flow	Unit: S
0038	40039	A Previous scale WAIT Timer	Unit: S
0039	40040	A Previous scale Discharge Timer	Unit: S
0040	40041	A Previous scale Total Timer	Unit: S
0041	40042	B Previous scale Coarse Flow Timer	Unit: S
0042	40043	B Previous scale Medium Flow	Unit: S
0043	40044	B Previous scale Fine Flow	Unit: S
0044	40045	B Previous scale WAIT Timer	Unit: S
0045	40046	B Previous scale Discharge Timer	Unit: S
0046	40047	B Previous scale Total Timer	Unit: S
0047	40047	Scale A packing finish signal Initial value: 0, 0~9999(this data will not be saved)	
0048	40048	Scale B packing finish signal Initial value: 0, 0~9999(this data will not be saved)	
0049	40050	Reserved	
Allow to read & write register			
Calibration parameter			
0050	40051	Unit	Initial value: 1. 0-g, 1-kg, 2-t, 3-lb
0051	40052	Decimal point	Initial value: 2 0-0 , 1-0.0, 2-0.00, 3-0.000, 4-0.0000.
0052	40053	Division	Initial value: 1, (1/2/5/10/20/50)
0053-0054	40054-40055	Maximum range	Initial value: 10000. The write range (maximum range value \leq minimum division*100000, not more than 999999.)
0055-0056	40056-40057	Scale A calibration with weights	Zero calibration with weights If write in 1, the present weight will be set as zero point, which is allow to write in when weigher platform is stable. Return to present zero voltage when read.
0057-0058	40058-40059		Gain calibration Input standard weight value(\leq maximum range);

			n with weights	Read relative zero millivolt of present load cell.
0059-0060	40060-40061	Scale A calibration without weights	Zero calibration without weights	Write millivolt value which is calibrated as zero. Return to present zero millivolt when reads.
0061-0062	40062-40063		Gain calibration with weights (gain millivolt value)	Write in millivolts of gain weight and save it. Returns to absolute millivolt of present weight when reads. (If present millivolt is too small or too large can not be calibrated then returns 0XFFFF.).
0063-0064	40064-40065		Gain calibration without weights (gain weight value)	Write in weight value of gain millivolt, user must write in gain millivolt before write in this value. Return to 0000H when reads.
0065-0066	40066-40067	Scale B calibration with weights	Referring to Scale A zero calibration with weights.	
0067-0068	40068-40069		Referring to Scale A gain calibration with weights	
0069-0070	40070-40071	Scale B calibration without weights	Referring to Scale A zero calibration without weights	
0071-0072	40072-40073		Referring to Scale A gain calibration without weights (gain millivolt value)	
0073-0074	40074-40075		Referring to Scale A gain calibration without weights (gain weight value)	
0075-0076	40076-40077	Manual Filling Timer	Initial Value: 0 Range:0.0~9.9	
0077-0078	40078-40079	A Material Calibration	Click the manual discharge in the material calibration, input the corresponding weight, and read it as 0 (note: it can only be used in the material calibration).	
0079-0080	40080-40081	B Material Calibration	Click the manual discharge in the material calibration, input the corresponding weight, and read it as 0 (note: it can only be used in the material calibration).	
0081-0099	40082-40100	Reserved		
Other parameters				
0100	40101	Recipe No.	Initial value: 1, range:1-40	
0101	40102	Batches	Initial value: 0, range: 0~9999	
0102	40103	Accumulative batches	Read-only	

0103	40104	Controller locked	0- unlocked; 1- locked
0104	40105	Year	0-99
0105	40106	Month	1-12
0106	40107	Day	1-31
0107	40108	Time	0-23
0108	40109	Minute	0-59
0109	40110	Second	0-59
0110~0119	Reserved		
Recipe parameters-quantity controlling			
0120-0121	40121-40122	Total target value	Weight value writing range: \leq Maximum range
0122-0123	40123-40124	Scale scale A target	Net Weigher: Weight value writing range: \leq The maximum capacity of single hopper Gross Weigher: Weight value writing range: \leq The maximum full capacity
0124-0125	40125-40126	Scale scale B target	
0126-0127	40127-40128	Scale A Coarse Flow leading quantity	
0128-0129	40129-40130	Scale A Medium Flow leading quantity	
0130-0131	40131-40132	Scale A free fall value	
0132-0133	40133-40134	Scale B Coarse Flow leading quantity	
0134-0135	40135-40136	Scale B Medium Flow leading quantity	
0136-0137	40137-40138	Scale B free fall value	
0138-0139	40139-40140	Zero zone value	
Recipe parameters-time controlling			
0140	40141	Delay before filling	Initial value: 0.5s Range: 0.0~99.9s.
0141	40142	Scale A Coarse Flow inhibit comparison timer	Initial value: 0.9s Range: 0.0~99.9s
0142	40143	Scale A Medium Flow inhibit comparison timer	Initial value: 0.9s Range: 0.0~99.9s
0143	40144	Scale A fine filling inhibit comparison timer	Initial value: 0.9s Range: 0.0~99.9s
0144	40145	Scale B Coarse Flow inhibit comparison timer	Initial value: 0.9s Range: 0.0~99.9s
0145	40146	Scale B Medium Flow inhibit comparison timer	Initial value: 0.9s Range: 0.0~99.9s
0146	40147	Scale B Fine Flow	Initial value: 0.9s

		inhibyte comparison timer	Range: 0.0~99.9s
0147	40148	Over/Under detection time	Initial value: 0.5s Range: 0.0~99.9s.
0148	40149	Value holding time	Initial value: 0.5s Range: 0.0~99.9s.
0149	40150	Discharge delay time	Initial value: 0.5s Range: 0.0~99.9s.
0150	40151	Discharge interlock time	Initial value: 0.5s Range: 0.0~99.9s.
0151	40152	Bag locked delay time	Initial value: 0.5s Range: 0.0~99.9s.
0152	40153	Bag unlocked delay time	Initial value: 0.5s Range: 0.0~99.9s.
0153	40154	Under level effective signal delay time	Initial value: 0.5s Range: 0.0~99.9s.
Recipe parameters-Over/Under detection time contolling			
0154	40155	Over/Under detection ON/OFF	Initial value : 0, 1: ON 0: OFF
0155	40156	Over/Under pause ON/OFF	Initial value : 0, 1: ON 0: OFF
0156-0157	40157-40158	Over value	Weight value writing in range \leq maximum range
0158-0159	40159-40160	Under value	
0160	40161	Under supplementary ON/OFF	Initial value: 0. 1: ON. 0: OFF
0161	40162	Under supplementary times	Range: 1 ~ 99. Initial value: 1
0162	40163	Effective filling time	Initial value: 0.5s. Range: 0.0~99.9s
0163	40164	Ineffective filling time	Initial value: 0.5s. Range: 0.0~99.9s
Recipe parameters - free fall correction controlling parameters			
0164	40165	Free fall correction ON/OFF	Initial value: 0, 1: ON. 0: OFF
0165	40166	Free fall correction times	Range: 1 ~ 99. Initial value: 1.
0166	40167	Free fall correction range	Range: 2.0, range: 0.0~9.9, unit:%
0167	40168	Free fall correction percentage	Initial value: 1. 0--100% correction; 1--50% correction; 2-25% correction.
0168	40169	Adaptive parameters real-time refresh ON/OFF	Initial Value: 0 0: dis-refresh 1: refresh in realtime
0169	40170	Hanger up delay timer	Initial Value : 5.5, range: 0-99.9
0170	40171	Hanger down delay	Initial Value : 5.5, range: 0-99.9

		timer	
Weighing parameter 1			
0200	40201	Power up auto-zero ON/OFF	Initial value: 0, 1: ON, 0: OFF
0201	40202	Zero range	Initial value: 50, range: 1-99
0202	40203	Stable range	Initial value: 2, stable range: 0 ~ 99d optional
0203	40204	Stable time	Initial value: 0.3s; range: 0.1~9.9 (s)
0204	40205	Zero tracking range	Initial value: 0, range: 0-9 (d)
0205	40206	Zero tracking time	Initial value: 2.0; range: 0.1~99.9s
0206	40207	Digital filtering level	Initial value: 7, range: 0-9
0207	40208	Secondary filter ON/OFF	Initial value: 1, 1: ON, 0: OFF.
0208	40209	AD sampling rate	Initial value: 1。 0:120; 1:240; 2:480; 3:960
0209~0214	40210~40215	Reserved	
Weighing parameter 2			
0215	40216	Auto-zero interval	Initial value: 0, range: 0-99. To enter zeroing after several packagings completed.
0216	40217	Valuing mode	Initial value: 0 (range: 0, 1.) 0: stable and value. 1: value delay.
0217	40218	Weight value holding Net Weigher ON/OFF	Initial value: 0; range: 0-1 (0: OFF; 1: ON)
0218	40219	Manual discharge accumulated ON/OFF	Initial value: 0; range: 0-1 (0: OFF; 1: ON)
0219	40220	Manual discharge bag locked adjustment ON/OFF	Initial value: 0; range: 0-1 (0: OFF; 1: ON)
0220	40221	Discharge real-time detection ON/OFF	Initial value: 0; range: 0-1 (0: OFF; 1: ON)
0221	40222	Gross/Net weight packaging mode (Gross Weigher)	Initial value: 1 (NW) 0: Gross weight packaging mode-Gross Weigher(filling after bag locked) 1: Net weight packaging mode-Gross Weigher(stable and tare after bag locked, then enter filling)
0222	40223	Dynamic filter ON/OFF	Initial value: 1; range: 0-1 (0: OFF; 1: ON) Parameters are valid when set ON.
0223	40224	Filling filter parameters	Initial value: 4, range: 1~9
0224	40225	Value filter	Initial value: 7, range: 1~9

		parameters	
0225	40226	Discharge filter parameters	Initial value: 3, range: 1~9
0226	40227	Adaptive Level	Initial value: 3, range: 1~5
0227	40228	Adaptive ON/OFF	Initial value : 0; range: 0~2 Optional 0: OFF; 1: 2-Speed Fill ; 2: 3-Speed Fill
0228~0229	40229~40230	Reserved	
Operating parameters - parameters structure			
0230	40231	Scale structure	Initial value: 0 0: Net Weigher, 1: Gross Weigher
0231	40232	Working mode	Initial value: 0 0: Dual AB Net Weigher 1: scale A Net Weigher, 2: scale B Net Weigher, 3: Dual hopper dula clip bag AB seprate 4: Dual hopper dula clip bag AB comb 5: AB seprate Gross Weigher 6: AB comb Gross Weigher 7: Bulk single hopper A 8: Bulk single hopper B, 9: Bulk scale AB independent 10: Bulk scale AB Interlock; Net Weigher write 0-4, Gross Weigher write 5-6, bulk scale write 7-10
0232	40233	Scale A & Scale B target value setting separately	Initial value: OFF. OFF: same target value ON: different target value
0233	40234	Filling mode	Initial value: 1 0: solo, 1: combination
0234	40235	Dual scale bag unlocked mode (Gross Weigher)	Initial value :: 0 0: closed; 1: bag unlocked simultaneously normal mode 2. bag unlocked simultaneously fast mode
0235-0236	40236-40237	Maximum capacity of solo hopper	The written range of weight values: ≤ maximum range
0237~0240	40238~40241	Reserved	
0241	40242	Manual Unlock Bag	Initial value :0; range: 0: OFF; 1: ON
0242	40243	Disable Unlock Bag When Running	Initial value :0; range: 0: OFF; 1: ON
0243~0249	Reserved		

Peripheral parameters-pat bag parameters(1)			
0250	40251	Pat bag mode	Initial value: 0. Net Weigher: 0/2. Gross Weigher: 0/1/2/3. 0: Closed. 1: Pat bag in filling. 2: Pat bag after valuing 3: Pat bag in filling and after valuing
0251	40252	Pat bag times in filling	Initial value: 0, range: 00-99
0252	40253	Pat bag times after valuing	Initial value: 4, range: 00-99
0253	40254	Pat bag before delay	Initial value: 0.5s. Range: 0.0 -99.9s
0254	40255	Pat bag effective time	Initial value: 0.5s. Range: 0.0 to 99.9s. Pat bag output effective time in the meantime.
0255	40256	Pat bag ineffective time	Initial value: 0.5s. Range: 0.0 to 99.9s. Pat bag output ineffective time in the meantime.
0256	40257	Pat bag extra effective time	Initial: 0.0, range: 0.0 to 99.9s
0257-0258	40258-40259	Pat bag started weight	Weight value written range: ≤ maximum capacity
Peripheral parameters - coding parameter (2)			
0259	40260	A code ON/OFF	Initial value: 0; range: 0-1 (0: OFF; 1: ON)
0260	40261	Coding start-up delay	Initial value: 0.5s, range: 0.0 to 99.9s
0261	40262	Coding output effective time	Initial value: 0.5s, range: 0.0 to 99.9 s
0262	40263	Allow to fill/discharge in coding	Initial value: 0 0: Allow to enter discharging output or filling output in coding. 1: Not allow to enter discharging output or filling output in coding.
Peripheral parameters — Hopper dual clampers, None-Hopper mode conveyer parameter (3)			
0263	40264	Conveyor ON/OFF	Initial value :0; range: 0: OFF; 1: ON
0264	40265	Conveyor start-up delay	Initial value : 0.5s, range 0-99.9
0265	40266	Conveyor running time	Initial value : 4.0s, range 0-99.9

0266	40267	Scale B delay start filling time (Gross Weigher)	Initial value : 2.0s, range 0-9.9
Peripheral parameters-print parameters (4)			
0267	40268	Auto print ON/OFF	Initial value: 0. 1: ON, 0: OFF
0268	40269	Print format	Initial value: 0 0: 24 lines 1: 32 lines
0269	40270	Print language	Initial value: 0.1: English: 0: Chinese
0270	40271	Print lines	Initial value: 3, 0-9
Peripherals Parameter—sewing parameter (5)			
0271	40272	sewing start delay;0.0~99.9s default: 0.5	
0272	40273	sewing output valid time;0.0~99.9s default: 0.5	
0273	40274	cutter output valid time;0.0~99.9s default: 0.5	
0274	40275	sewing delay before stop;0.0~99.9s default: 0.5	
Peripherals Parameter—discharge patting parameter (6)			
0275	40276	discharge patting ON/OFF;0:OFF; 1:ON, default: 0	
0276	40277	discharge valid time;0.0~9.9, default 0.5s	
0277	40278	discharge patting valid time;0.0~9.9, default 0.5s	
0278	40279	discharge patting in valid time;0.0~9.9, default 0.5s	
0279	40280	discharge patting times;0~99, default 10	
Peripherals Parameter—Filling/Discharge Overtime ON/OFF (7)			
0280	40281	Filling/Discharge Overtime ON/OFF;0 ~1 default 0	
0281	40282	A:Coarse Flow Overtime ;0.0~99.9s default 5.0s	
0282	40283	A:Medium Flow Overtime;0.0~99.9s default 5.0s	
0283	40284	A:Manual Fine Overtime;0.0~99.9s default 5.0s	
0284	40285	A:Discharge Overtime;0.0~99.9s default 5.0s	
0285	40286	B:Coarse Flow Overtime;0.0~99.9s default 5.0s	
0286	40287	B:Medium Flow Overtime;0.0~99.9s default 5.0s	
0287	40288	B:Manual Fine Overtime;0.0~99.9s default 5.0s	
0288	40289	B:Discharge Overtime;0.0~99.9s default 5.0s	
0289	40290	Cutter Work Delay Timer;0.0~99.9s default 0.5s	
0290	40291	Sewing ON/OFF;Initial value: 0, 1: ON 0: OFF	
0291	40292	Sewing deshaking timer;Initial value: 0.3, 0~99.9s	
0292~0299	40293~40300	Reserved	
Communication parameters - serial port1 parameters (1)			
0300	40301	ID No.	Scale no., Broadcast (0xFF) may modify the current ID.
0301	40302	Communication mode	Initial value: Modbus-RTU 0: Modbus-RTU ; 1: Print 2: Continuous Send 3: Re-ContA

			4: Re-ContB
0302	40303	Baud rate	range: 0: 9600; 1: 19200; 2: 38400; 3: 57600; 4: 115200 default: 2 (38400)
0303	40304	Data format	range: 0: 8-E-1; 1: 8-N-1; 2: 7-E-1; 3: 7-N-1 default: 0 (8-E-1)
0304	40305	Hi-Lo digit	MODBUS double word register storing order. Range: 0-1 (0: Hi-Lo; 1: Lo-Hi) Default: 0 (Hi-Lo)
Communication parameters – serial port 2 parameters (2)			
0305	40306	ID	Scale no., Broadcast (0xFF) may modify the current ID.
0306	40307	Communication mode	Initial value: Modbus-RTU 0: Modbus-RTU ; 1: Print 2: Continuous Send 3: Re-ContA 4: Re-ContB
0307	40308	Baud rate	range: 0: 9600; 1: 19200; 2: 38400; 3: 57600; 4: 115200 default: 2 (38400)
0308	40309	Data format	range: 0: 8-E-1; 1: 8-N-1; 2: 7-E-1; 3: 7-N-1 default: 0 (8-E-1)
0309	40310	Hi-Lo digit	MODBUS double word register storing order. Range: 0-1 (0: Hi-Lo; 1: Lo-Hi) Default: 0 (Hi-Lo)
Cumulative print			
0310	40311	Print accumulated	Read 0. Write 1, print accumulated.
0311	40312	Print recipe accumulated	Read 0. Write 0: print present recipe accumulated Write 1-40 print the corresponding accumulated recipes Write 41, print all accumulated recipes
0312	40313	Print accumulated user	Read 0. Write 100, print current user accumulated. Write 0-9, print corresponding user accumulated.

			Write 101, print all user accumulated.
0313-0319	Reserved		
Reset			
0320	40321	Reset	8800 All parameters restore factory settings 8801 Calibration recovery 8802 Recovery weighing parameters 8803 Recovery formula 8804 IO definition of recovery 8805 Perform backups 8806 Implementation of recovery Read returns 0
I/O Module test Parameter			
0321	40322	Start/Stop I/O test	Write 1 Start I/O module test Write 0 ESC I/O module test state, stop state can write in Read: Return current I/O module test ON/OFF's state
0322	40323	Input I/O module test	Write: not allowed. Read: IN1~12 matches with Lo-Hi. 1: valid input, 0: invalid input.
0323-0324	40324-40325	Output I/O module test	Write: OUT1~16 matches with Lo-Hi, could be written when set ON. 1: valid output, 0: invalid output. Read: return to I/O module state, OUT1~16 matches with Lo-Hi. 1: valid output, 0: invalid output.
0325-0349	Reserved		
I/O Module user-defined Parameters			
0350	40351	Input port 1 is defined.	Write: Write function corresponding to the value. If defined IN as running, user has to write 1 in according register of IN. Read: Returns to I/O module state.
0351	40352	Input port 2 is defined.	
0352	40353	Input port 3 is defined.	
0353	40354	Input port 4 is defined.	
0354	40355	Input port 5 is defined.	
0355	40356	Input port 6 is defined.	
0356	40357	Input port 7 is defined.	
0357	40358	Input port 8 is defined.	

0358	40359	Input port 9 is defined.	<p>Write: Write function corresponding to the value. If defined OUT as running, user has to write 1 in according register of OUT. Read: Returns to I/O module state.</p>
0359	40360	Input port 10 is defined.	
0360	40361	Input port 11 is defined.	
0361	40362	Input port 12 is defined.	
0362	40363	Output port 1 is defined.	
0363	40364	Output port 2 is defined.	
0364	40365	Output port 3 is defined.	
0365	40366	Output port 4 is defined.	
0366	40367	Output port 5 is defined.	
0367	40368	Output port 6 is defined.	
0368	40369	Output port 7 is defined.	
0369	40370	Output port 8 is defined.	
0370	40371	Output port 9 is defined.	
0371	40372	Output port 10 is defined.	
0372	40373	Output port 11 is defined.	
0373	40374	Output port 12 is defined.	
0374	40375	Output port 13 is defined.	
0375	40376	Output port 14 is defined.	
0376	40377	Output port 15 is defined.	
0377	40378	Output port 16 is defined.	
0378-0399	Reserved		
Target value of 40 recipes parameters (read and write)			
0400-0401	40401-40402	Target value of recipe 1;Initial value: 0	
0402-0403	40403-40404	Target value of recipe 2;Initial value: 0	
0404-0405	40405-40406	Target value of recipe 3;Initial value: 0	
0406-0407	40407-40408	Target value of recipe 4;Initial value: 0	
o o o		o o o o o o o o o o o o o o	
0478-0479	40479-40480	Target value of recipe 40;Initial value: 0	
0480-0499	Reserved		
Scale A target value parameters of 40 recipes (read and write)			
0500-0501	40501-40502	Target value of recipe 1A;Initial value: 0 (Read only)	

0502-0503	40503-40504	Target value of recipe 2A;Initial value: 0
0504-0505	40505-40506	Target value of recipe 3A;Initial value: 0
0506-0507	40507-40508	Target value of recipe 4A;Initial value: 0
...	
0578-0579	40579-40580	Target value of recipe 40A;Initial value: 0
0580-0599	Reserved	
Scale B target value parameters of 40 recipes (read and write)		
0600-0601	40601-40602	Target value of recipe 1B;Initial value: 0
0602-0603	40603-40604	Target value of recipe 2B;Initial value: 0
0604-0605	40605-40606	Target value of recipe 3B;Initial value: 0
0606-0607	40607-40608	Target value of recipe 4B;Initial value: 0
...	
0678-0679	40679-40680	Target value of recipe 40B;Initial value: 0
0680-0699	Reserved	
Accumulated weight parameters of 40 recipes.		
0700-0701	40701-40702	Accumulated weight of recipe 1
0702-0703	40703-40704	Accumulated weight of recipe 2
0704-0705	40705-40706	Accumulated weight of recipe 3
0706-0707	40707-40708	Accumulated weight of recipe 4
...	
0778-0779	40779-40780	Accumulated weight of recipe 40
0780-0799	Reserved	
Accumulated bags parameters of 40 recipes.		
0800-0801	40801-40802	Accumulated bags of recipe 1(Written 0 to clear accumulated weight and bags of the recipe.)
0802-0803	40803-40804	Accumulated bags of recipe 2(Written 0 to clear accumulated weight and bags of the recipe.)
0804-0805	40805-40806	Accumulated bags of recipe 3(Written 0 to clear accumulated weight and bags of the recipe.)
0806-0807	40807-40808	Accumulated bags of recipe 4(Written 0 to clear accumulated weight and bags of the recipe.)
....	
0878-0879	40879-40880	Accumulated bags of recipe 40(Written 0 to clear accumulated weight and bags of the recipe.)
0880-0899	Reserved	
10 users cumulative weight		
0900-0901	40901-40902	User 0 accumulated weight (Written 0 to clear accumulated weight and bags of the user.)
0902-0903	40903-40904	User 1 accumulated weight (Written 0 to clear accumulated weight and bags of the user.)

0904-0905	40905-40906	User 2 accumulated weight (Written 0 to clear accumulated weight and bags of the user.)
0906-0907	40907-40908	User 3 accumulated weight (Written 0 to clear accumulated weight and bags of the user.)
0908-0909	40909-40910	User 4 accumulated weight (Written 0 to clear accumulated weight and bags of the user.)
.....	
0918-0919	40919-40920	User 9 accumulated weight (Written 0 to clear accumulated weight and bags of the user.)
0920-0949	Reserved	
10 users cumulative number of times		
0950-0951	40951-40952	User accumulated times 0 (Written 0 to clear accumulated weight and bags of the user.)
0952-0953	40953-40954	User accumulated times 1 (Written 0 to clear accumulated weight and bags of the user.)
0954-0955	40955-40956	User accumulated times 2 (Written 0 to clear accumulated weight and bags of the user.)
.....	
0968-0969	40969-40970	User accumulated times 9 (Written 0 to clear accumulated weight and bags of the user.)
0970-0999	40971-41000	Reserved
1000	41001	Filling mode: 0: air drive(default); 1: electric drive
1001	41002	Motor group: 0 (default); range: 0-4 optional
1002	41003	Filling stepper motor frequency of scale A : 1-50000 optional; initial value: 12000
1003-1004	41004-41005	A filling close to Motor Steps For Fi-Flow range : 1-60000
1005-1006	41006-41007	A filling close to Motor Steps For Me -Flow
1007-1008	41008-41009	A filling close to Motor Steps For Co -Flow
1009	41010	The motor rotation direction signal of scale A fill gate ON/OFF
1010	41011	Filling stepper motor frequency of scale B
1011-1012	41012-41013	B filling close to Motor Steps For Fi-Flow
1013-1014	41014-41015	B filling close to Motor Steps For Me -Flow
1015-1016	41016-41017	B filling close to Motor Steps For Co -Flow
1017	41018	The motor rotation direction signal of scale B fill gate ON/OFF
1018	41019	Scale A filling motor start frequency
1019	41020	Scale A filling motor acceleration time
1020	41021	Scale A filling motor deceleration time

1021	41022	Scale B filling motor start frequency
1022	41023	Scale B filling motor acceleration time
1023	41024	Scale B filling motor deceleration time
1024	41025	The running time of scale A filling gate opens to Coarse Flow. (Normal motors)
1025	41026	The running time of scale A filling gate opens to Medium Flow.
1026	41027	The running time of scale A filling gate opens to Fine Flow.
1027	41028	The running time of scale B filling gate opens to Coarse Flow.
1028	41029	The running time of scale B filling gate opens to Medium Flow.
1029	41030	The running time of scale B filling gate opens to Fine Flow.
1030	41031	Filling gate closed timeout
1031	41032	Motor filling gate opened anti logically
1032	41033	Bag locked mode
1033	41034	Bag locked frequency of scale A (Stepper motor)
1034	41035	Bag unlocked frequency of scale A
1035-1036	41036-41037	Pulses quantity required that state of bag unlocked state turns to bag locked state of scale A motor
1037	41038	The motor rotation direction signal of scale A bag locked
1038	41039	Motor frequency of scale B bag locked
1039	41040	Motor frequency scale B bag unlocked
1040-1041	41041-41042	Pulses quantity required that state of bag unlocked turns to bag locked of scale B motor
1042	41043	The motor rotation direction signal of scale B bag locked
1043	41044	Scale A bag locked motor start frequency
1044	41045	Scale A bag locked motor acceleration time
1045	41046	Scale A bag locked motor deceleration time
1046	41047	Scale B bag locked motor start frequency
1047	41048	Scale B bag locked motor acceleration time
1048	41049	Scale B bag locked motor deceleration time
1049	41050	Bag unlocked time (Normal motor)
1050	41051	Bag unlocked timeout
1051	41052	Bag locked timeout
1052	41053	Motor bag locked anti logically ON/OFF
1053	41054	Discharge mode
1054	41055	Scale A discharge gate opened motor frequency
1055	41056	Scale A discharge gate closed motor frequency
1056-1057	41057-41058	Pulses quantity required that state of closed turns to opened of scale A motor
1058	41059	The signal of motor rotation direction of scale A discharge gate opened
1059	41060	The motor frequency of scale B discharge gate opened
1060	41061	The motor frequency of scale B discharge gate closed

1061-1062	41062-41063	Pulses quantity required that state of closed turns to opened of scale B motor	
1063	41064	The signal of motor rotation direction of scale B discharge gate opened	
1064	41065	Scale A discharge motor started frequency	
1065	41066	Scale A discharge motor acceleration time	
1066	41067	Scale A discharge motor deceleration time	
1067	41068	Scale B discharge motor started frequency	
1068	41069	Scale B discharge motor acceleration time	
1069	41070	Scale B discharge motor deceleration time	
1070	41071	Scale A discharge motor gate opened signal output time (Normal motors)	
1071	41072	Scale B discharge motor gate opened signal output time	
1072	41073	Discharge gate closed timeout	
1073	41074	Discharge gate opened timeout	
1074	41075	Motor discharge ON/OFF anti logically	
1075	41076	Discharge limit digit real-time detection ON/OFF	
1076	41077	Motor group no. of present recipe	
Peripherals Parameter—Auxiliary Pulse Parameter (8)			
1079	41080	Auxiliary Pulse ON/OFF;Initial value: 0, 1: ON 0: OFF	
1080	41081	Auxiliary Pulse 1 Execute Total Timer 0.0~999.9s default 0(If it's 0, it keeps operating)	
1081	41082	Auxiliary Pulse 1 On Timer;0.0~999.9s default 10.0s	
1082	41083	Auxiliary Pulse 1 Off Timer ;0.0~999.9s default 10.0s	
1083	41084	Auxiliary Pulse 2 Execute Total Timer 0.0~999.9 s default 0(If it's 0, it keeps operating)	
1084	41085	Auxiliary Pulse 2 On Timer;0.0~999.9s default 10.0s	
1085	41086	Auxiliary Pulse 2 Off Timer ;0.0~999.9s default 10.0s	
1086	41087	Auxiliary Pulse 3 Execute Total Timer 0.0~999.9 min default 0(If it's 0, it keeps operating)	
1087	41088	Auxiliary Pulse 3 On Timer;0.0~999.9 min default 10.0 min	
1088	41089	Auxiliary Pulse 3 Off Timer ;0.0~999.9 min default 10.0 min	
1089	41090	Auxiliary Pulse 4 Execute Total Timer 0.0~999.9 min default 0(If it's 0, it keeps operating)	
1090	41091	Auxiliary Pulse 4 On Timer;0.0~999.9 min default 10.0 min	
1091	41092	Auxiliary Pulse 4 Off Timer ;0.0~999.9 min default 10.0 min	
Ethernet port parameter			
1100	41101	Hi-Lo	Initial value 0. range: 0: AB-CD (Hi ahead); 1: CD-AB (Lo ahead)
1101	41102	Port No.	Initial value 502. range 1~65535

1102	41103	IP	IP1
1103	41104		IP2
1104	41105		IP3
1105	41106		IP4
1106	41107	MAC Address	MAC1
1107	41108		MAC2
1108	41109		MAC3
1109	41110		MAC4
1110	41111		MAC5
1111	41112		MAC6
Auxiliary Logic programme 1			
1150	41151	Type	Initial Value:0; range 0~5
			0: OFF
			1: Delay Connect
			2: Delay disconnect
			3: Delay connect and delay disconnect
			4: invalid-valid trigger
5: valid-invalid trigger			
1151	41152	Trigger Signal	Initial value: 0 ; range: 0~64 Optional customization trigger input, fix I/O Module input 1~12, I/O Module output define, weight value trigger
1152	41153	Trigger Input Signal Port	Initial value: 0 ; range: 0~12 Select the signal corresponding to the I/O Module input port 0~12, input port-0 stands for do not define this function.
1153	41154	Output Signal Port	Initial value: 0 ; range: 0~16 Select the signal corresponding to the I/O Module input port 0~16, input port-0 stands for do not define this function.
1154	41155	Delay Connect Timer	Initial value: 0 ; range: 0~99.9
1155	41156	Delay Disconnect Timer	Initial value: 0 ; range: 0~99.9
1156	41157	Signal Output Valid Timer	Initial value: 0 ; range: 0~99.9
1157-1158	41158~41159	Threshold Weight	Initial value: 0 ; range: 0~maximum range
1159~1169	41160~41170	Reserved	
Auxiliary Logic programme 2			
1170	41171	Type	Initial Value:0; range 0~5
			0: OFF

			1: Delay Connect 2: Delay disconnect 3: Delay connect and delay disconnect 4: invalid-valid trigger 5: valid-invalid trigger
1171	41172	Trigger Signal	Initial value: 0 ; range: 0~64 Optional customization trigger input, fix I/O Module input 1~12 , I/O Module output define, weight value trigger
1172	41173	Trigger Input Signal Port	Initial value: 0 ; range: 0~12 Select the signal corresponding to the I/O Module input port 0~12, input port-0 stands for do not define this function.
1173	41174	Output Signal Port	Initial value: 0 ; range: 0~16 Select the signal corresponding to the I/O Module input port 0~16, input port-0 stands for do not define this function.
1174	41175	Delay Connect Timer	Initial value: 0 ; range: 0~99.9
1175	41176	Delay Disconnect Timer	Initial value: 0 ; range: 0~99.9
1176	41177	Signal Output Valid Timer	Initial value: 0 ; range: 0~99.9
1177-1178	41178~41179	Threshold Weight	Initial value: 0 ; range: 0~maximum range
1179~1189	41180~41190	Reserved	
Auxiliary Logic programme 3			
			Initial Value:0; range 0~5 0: OFF 1: Delay Connect 2: Delay disconnect 3: Delay connect and delay disconnect 4: invalid-valid trigger 5: valid-invalid trigger
1190	41191	Type	
1191	41192	Trigger Signal	Initial value: 0 ; range: 0~64 Optional customization trigger input, fix I/O Module input 1~12 , I/O Module output define, weight value trigger
1192	41193	Trigger Input Signal Port	Initial value: 0 ; range: 0~12 Select the signal corresponding

			to the I/O Module input port 0~12, input port-0 stands for do not define this function.
1193	41194	Output Signal Port	Initial value: 0 ; range: 0~16 Select the signal corresponding to the I/O Module input port 0~16, input port-0 stands for do not define this function.
1194	41195	Delay Connect Timer	Initial value: 0 ; range: 0~99.9
1195	41196	Delay Disconnect Timer	Initial value: 0 ; range: 0~99.9
1196	41197	Signal Output Valid Timer	Initial value: 0 ; range: 0~99.9
1197-1198	41198~41199	Threshold Weight	Initial value: 0; Range: 0~maximum range
1199~1209	41200~41210	Reserved	
Auxiliary Logic programme 4			
1210	41211	Type	Initial Value:0; range 0~5
			0: OFF
			1: Delay Connect
			2: Delay disconnect
			3: Delay connect and delay disconnect
			4: invalid-valid trigger
5: valid-invalid trigger			
1211	41212	Trigger Signal	Initial value: 0 ; range: 0~64 Optional customization trigger input, fix I/O Module input 1~12, I/O Module output define, weight value trigger
1212	41213	Trigger Input Signal Port	Initial value: 0 ; range: 0~12 Select the signal corresponding to the I/O Module input port 0~12, input port-0 stands for do not define this function.
1213	41214	Output Signal Port	Initial value: 0 ; range: 0~16 Select the signal corresponding to the I/O Module input port 0~16, input port-0 stands for do not define this function.
1214	41215	Delay Connect Timer	Initial value: 0 ; range: 0~99.9
1215	41216	Delay Disconnect Timer	Initial value: 0 ; range: 0~99.9
1216	41217	Signal Output Valid Timer	Initial value: 0 ; range: 0~99.9

1217-1218	41218~41219	Threshold Weight	Initial value: 0;Range: 0~maximum range
1219~1229	41220~41230	Reserved	
Auxiliary Logic programme 5			
1250	41251	Type	Initial Value:0; range 0~5
			0: OFF
			1: Delay Connect
			2: Delay disconnect
			3: Delay connect and delay disconnect
			4: invalid-valid trigger
			5: valid-invalid trigger
1251	41252	Trigger Signal	Initial value: 0 ; range: 0~64 Optional customization trigger input, fix I/O Module input 1~12 , I/O Module output define, weight value trigger
1252	41253	Trigger Input Signal Port	Initial value: 0 ; range: 0~12 Select the signal corresponding to the I/O Module input port 0~12, input port-0 stands for do not define this function.
1253	41254	Output Signal Port	Initial value: 0 ; range: 0~16 Select the signal corresponding to the I/O Module input port 0~16, input port-0 stands for do not define this function.
1254	41255	Delay Connect Timer	Initial value: 0 ; range: 0~99.9
1255	41256	Delay Disconnect Timer	Initial value: 0 ; range: 0~99.9
1256	41257	Signal Output Valid Timer	Initial value: 0 ; range: 0~99.9
1257-1258	41258~41259	Threshold Weight	Initial value: 0;Range: 0~maximum range
1259~1269	41260~41270	Reserved	
Logic Trigger 6			
1270	41271	Type	Initial Value:0; range 0~5
			0: OFF
			1: Delay Connect
			2: Delay disconnect
			3: Delay connect and delay disconnect
			4: invalid-valid trigger
			5: valid-invalid trigger
1271	41272	Trigger Signal	Initial value: 0 ; range: 0~64

			Optional customization trigger input, fix I/O Module input 1~12, I/O Module output define, weight value trigger
1272	41273	Trigger Input Signal Port	Initial value: 0 ; range: 0~12 Select the signal corresponding to the I/O Module input port 0~12, input port-0 stands for do not define this function.
1273	41274	Output Signal Port	Initial value: 0 ; range: 0~16 Select the signal corresponding to the I/O Module input port 0~16, input port-0 stands for do not define this function.
1274	41275	Delay Connect Timer	Initial value: 0 ; range: 0~99.9
1275	41276	Delay Disconnect Timer	Initial value: 0 ; range: 0~99.9
1276	41277	Signal Output Valid Timer	Initial value: 0 ; range: 0~99.9
1277-1278	41278~41279	Threshold Weight	Initial value: 0; range: 0~maximum range
1279~1299	41280~41300	Reserved	
1300	41301	A feeding motor returns to zero frequency (Initial value : 2000; range: 0~50000)	
1301	41302	B feeding motor returns to zero frequency (Initial value : 2000; range : 0~50000)	
1302	41303	A Clamper motor returns to zero frequency (Initial value : 2000; range : 0~50000)	
1303	41304	B Clamper motor returns to zero frequency (Initial value : 2000; range : 0~50000)	
1304	41305	A DICS motor returns to zero frequency (Initial value : 2000; range : 0~50000)	
1305	41306	B DICS motor returns to zero frequency (Initial value : 2000; range : 0~50000)	
1306~1999	41306~42000	Reserved	

ACUM parameters

2000-2001	42001-42002	Total cumulative weight is 6 digits
2002-2003	42003-42004	The total cumulative weight low 9
2004-2005	42005-42006	Total accumulative number
2006-2007	42007-42008	the current formula accumulation is 6 digits higher
2008-2009	42009-42010	the current formula accumulation is 9 digits lower
2010-2011	42011-42012	Accumulative number of current formulation

2012~2013	42013~42014	the accumulations of current users is 6 digits higher	
2014~2015	42015~42016	the accumulations of current users is 9 digits lower	
2016~2017	42017~42018	Total number of current user counts	
2018~2019	42019~42020	Formula 1 cumulative weight is 6 digits high	
2020~2021	42021~42022	Formulation 1 cumulative weight low 9	
2022~2023	42023~42024	Formula 1 cumulative count	
2024~2251	42025~42252	<i>Recipe 2-39 ACUM Information</i>	
2252~2253	42253~42254	Formulation 6 High 40 cumulative weight	
2254~2255	42255~42256	Formulation 40 cumulative weight low 9	
2256~2257	42257~42258	Formula 40 cumulative times	
2258~2259	42259~42260	User 1 cumulative weight is 6 digits high	
2260~2261	42261~42262	User 1 cumulative weight is 9 digits lower	
2262~2263	42263~42264	User 1 cumulative times	
2264~2311	42265~42312	<i>User 1-9 ACUM Information</i>	
2312~2313	42313~42314	User 10 cumulative weight is 6 digits high	
2314~2315	42315~42316	User 10 cumulative weight is 9 digits lower	
2316~2317	42317~42318	User 10 cumulative times	
2318	42319	Clear All Recipes ACUM	Write 1 clear total accumulation
2319	42320	Clear recipe ACUM	Write 1-20 to clear the Recipe ID ACUM; Write 100 to Clear Choose Recipe ACUM; Write 101 to Clear All Recipe ACUM.
2320	42321	Clear user ACUM	Read as 0 . Write 0-9 to clear the user ID ACUM ; Write 100 to clear choose user ACUM ; Write 101 to clears all user ACUM.
2321~29999	42322~43000	Reserved	
3000~3001	43001~43002	Current flow	Current flow value.
3002	43003	Flow calculation window length; 1 ~ 6	
3003	43004	Current flow unit	Read only: 0: g/h;1 kg/h.2: t/h;3: lb/h.
3004	43005	Current flow point	Read only: 0:0 bits;1:1 bits;2:2 bits;3:3 bits;Four to four.

3005~3006	43006~43007	Total quantity delivered Hi 6 bits; 0~999999	
3007~3008	43008~43009	Total quantity delivered low 9 bits; 0~999999999	
3009~3010	43010~43011	Cumulative times of receipt and delivery; 0~999999999	
3011~3012	43012~43013	Cumulative weight of receipt and delivery Hi 6 bits ; 0~999999	
3013~3014	43014~43015	Cumulative weight of receipt and delivery low 9 bits; 0~999999999	
3015~3016	43016~43017	Total cumulative times of the system ; 0~999999999	
3017~3018	43018~43019	Total cumulative weight of the system is Hi 6 bits 0~999999	
3019~3020	43020~43021	The total cumulative weight of the system is low 9 bits ; 0~999999999	
3021~89999	Reserved		
Compile information (front and back)			
9000-9001	49001-49002	Logic Version ID; For example: 010000	
9002-9003	49003-49004	Compile Date; For example: 161201	
9004-9005	49005-49006	Compile Time; For example: 130805	
9006-9007	49007-49008	Additional version ID; For example: 100	
9008-9011	49009~49012	Reserved	
The following is a read-write bits (reading function codes: 0x01, writing function code: 0x05)			
Coil ON/OFF of GM9907-LD controlling function			
0000	00001	Power-Up Zero	Write 1 on, 0 is written off. Each switching state is read out
0001	00002	Advance Filter ON/OFF	
0002	00003	Result Holding	
0003	00004	Add toTotal When Manual Discharge	
0004	00005	Manual Discharge request bag locked	
0005	00006	Gross/Net weight Gross Weigher	
0006	00007	Dynamic Filter	
0007	00008	Target value of scale A & scale B setting individually	
0008	00009	OVER/UNDER ON/OFF	

0009	00010	OVER/UNDER Pause		
0010	00011	Compensation ON/OFF		
0011	00012	Auto Free Fall Correction ON/OFF		
0012	00013	Coding Device ON/OFF		
0013	00014	Coding allow filling/discharge ON/OFF		
0014	00015	Conveyor ON/OFF		
0015	00016	Print ON/OFF		
0016	00017	A Adaptive Pause		
0017	00018	B Adaptive Pause		
0018	00019	Adaptive parameter update ON/OFF		
0019	0020	Reserved	The address can write in 1 only, read out 0.	
0020	00021	Scale A zero		
0021	00022	Scale A manual discharge		
0022	00023	Scale A manual Fine Flow		
0023	00024	Scale A bag locked/unlocked		
0024	00025	Scale A Manual Filling		
0025	00026	Scale A Manual Medium Filling		
0026	00027	A Hanger up		Write 1 ON, write 0 OFF read out is each ON/OFF state
0027	00028	B Hanger up		
0028-29	Reserved			The address can write in 1 only, read out 0.
0030	00031	Scale B zero		
0031	00032	Scale B manual discharge		
0032	00033	Scale B manual Fine Flow		
0033	00034	Scale B bag locked/unlocked		
0034	00035	Scale B manual filling		
0035	00036	Scale B Manual Medium Filling		

0036-0039	0037-0040	Reserved	
0040	00041	Run	This address can be written only 1. Read as 0
0041	00042	Emergency stop	
0042	00043	PAUSE	
0043	00044	Select recipes	
0044	00045	Clear alarm	
0045	00046	Clear present user accumulated	
0046	00047	Clear all users accumulated	
0047	00048	Clear present recipe accumulated	
0048	00049	Clear all recipes accumulated	
0049	00050	Clear accumulated total	
0050	00051	All reset	
0051	00052	Calibration reset	
0052	00053	Working parameters reset	
0053	00054	Recipe parameters reset	
0054	00055	Peripheral parameters reset	
0055	00056	I/O module parameters reset	
0056	00057	Execution parameter backup	
0057	00058	Restore backup parameters	
0058	00059	Delete backup parameters	The address can write in 1 to delete backup parameters. If reads out 1, means backup parameter is available. If reads out 0, means without backup parameters.
0059	00060	Motor parameters reset	This address can only write 1. Read to 0
0060	00061	Sewing Input	
0061	00062	Sewing Emergency Stop	
0062	00063	Auxiliary Pulse 1	

0063	00064	Auxiliary Pulse 2	
0064	00065	Auxiliary Pulse 3	
0065	00066	Auxiliary Pulse 4	
0066	00067	Auxiliary Logic parameter Reset	
0067	00068	Clear Current Recipe	
0068-0079	Reserved		
Controlling function coil IO test			
0080	00081	I/O module test ON/OFF: to enter I/O module test by writing 1, exit by writing 0. Not allow to write when running.	Do not take effect during writing.
0081	00082	Read out 1 when input port 1 is valid. If invalid, will read out 0.	
0082	00083	Read out 0 when input port 2 is valid. If invalid, will read out 0.	
0083	00084	Read out 1 when input port 3 is valid. If invalid, will read out 0.	
0084	00085	Read out 1 when input port 4 is valid. If invalid, will read out 0.	
0085	00086	Read out 1 when input port 5 is valid. If invalid, will read out 0.	
0086	00087	Read out 1 when input port 6 is valid. If invalid, will read out 0.	
0087	00088	Read out 1 when input port 7 is valid. If invalid, will read out 0.	
0088	00089	Read out 1 when input port 8 is valid. If invalid, will read out 0.	
0089	00090	Read out 1 when input port 9 is valid. If invalid, will read out 0.	
0090	00091	Read out 1 when input port 10 is valid. If invalid, will read out 0.	
0091	00092	Read out 1 when input port 11 is valid. If invalid, will read out 0.	
0092	00093	Read out 1 when input port 12 is valid. If invalid, will read out 0.	
0093	00094	Read out 1 when output port 1 is valid. If invalid, will read out 0.	
0094	00095	Read out 1 when output port 2 is valid. If invalid, will read out 0.	

0095	00096	Read out 1 when output port 3 is valid. If invalid, will read out 0.
0096	00097	Read out 1 when output port 4 is valid. If invalid, will read out 0.
0097	00098	Read out 1 when output port 5 is valid. If invalid, will read out 0.
0098	00099	Read out 1 when output port 6 is valid. If invalid, will read out 0.
0099	00100	Read out 1 when output port 7 is valid. If invalid, will read out 0.
0100	00101	Read out 1 when output port 8 is valid. If invalid, will read out 0.
0101	00102	Read out 1 when output port 9 is valid. If invalid, will read out 0.
0102	00103	Read out 1 when output port 10 is valid. If invalid, will read out 0.
0103	00104	Read out 1 when output port 11 is valid. If invalid, will read out 0.
0104	00105	Read out 1 when output port 12 is valid. If invalid, will read out 0.
0105	00106	Read out 1 when output port 13 is valid. If invalid, will read out 0.
0106	00107	Read out 1 when output port 14 is valid. If invalid, will read out 0.
0107	00108	Read out 1 when output port 15 is valid. If invalid, will read out 0.
0108	00109	Read out 1 when output port 16 is valid. If invalid, will read out 0.

6.4 Re-ContA/B protocol

In this way, no need to send any command to the weighing display, display automatically sends the collected data to the computer

Returns a description of the data frame format:

Status	,	GS/NT	,	+/-	Display value	Unit	CR	LF
2 Units	2C	47 53 /4E 54	2C	2B/2D	7 Units		0D	0A

Explain:

Status——**2** Unit, **OL**(Over):**4FH 4CH**; **ST**(Stable):**53H 54H**; **US**(Unstable):**55H 53H**
GW/NW——**2** Unit, **GS/NT**: **47 53/4E 54**

Display value—— **7** Unit, Contains the decimal point, no decimal point when the high space

Unit ——**2** Unit, g: **20 67**; kg: **6B 67**; t: **20 74**; lb: **6C 62**

For example:

When weighing the display automatically sends the following frame of data:

53 54 2C 47 53 2C 2B 30 31 31 2E 31 32 30 6B 67 0D 0A

Current status: Stable, data value is positive, display value is **11.120kg**

7. Auto packaging process

GM9907-LD The controller in the packaged state can be automatically controlled automatic packaging coarse, medium and fine flow, and discharge of all the packaging process. Supports hopper, Gross Weigher scale and bulk scale structure, a variety of modes are available. Scale structure and mode can be selected in the operating parameters.

7.1 Dual scale Net Weigher mode packaging

1) Weigher structure choose with weighing hopper, the mode selection parameter for the scale body is dual scale Net Weigher AB, AB individually set to off target, target value is set greater than the hopper volume, if the target value is a hopper volume integral multiple of "the number of discharge calculated automatically" as a target value / hopper volume. Otherwise, "the number of discharge calculated automatically" as a target value / hopper volume +1 single hopper, and single scale target value is target value / unloading times automatically calculated. After starting the main interface can see A, B and the target value, then A, B parallel hopper discharge, who measure who discharge first. A total discharge "Automatic counting of discharge times" unlocks bag only once.

2) Weigher structure choose with weighing hopper, the mode selection parameter for the scale body is dual scale Net Weigher AB, AB individually set to off target, single target value is set equal to less than the hopper volume, then the "number of discharge automatically calculated " is 1, single hopper target is a target value. In this case A, B are alternately discharge, discharge once unlock bag once.

3) Weigher structure choose with weighing hopper, the mode selection parameter for the scale body is dual scale Net Weigher AB, AB target value is set to on separately, In AB scale independent mode, need to set A or B target value, but single hopper can not exceed the hopper volume, the largest capacity of single hopper can not exceed the volume; Do not set target value at this time, even if setted is meaningless. Scale A and scale B respectively complete the quantitative process according to the target value of A or target value of B set respectively, and the unloading process of the two scales is separate, that is, when scale A is unloading, scale B needs to wait for the unloading completion of scale A even if the filling is completed, and then the unloading can be done after the bag is lock again.

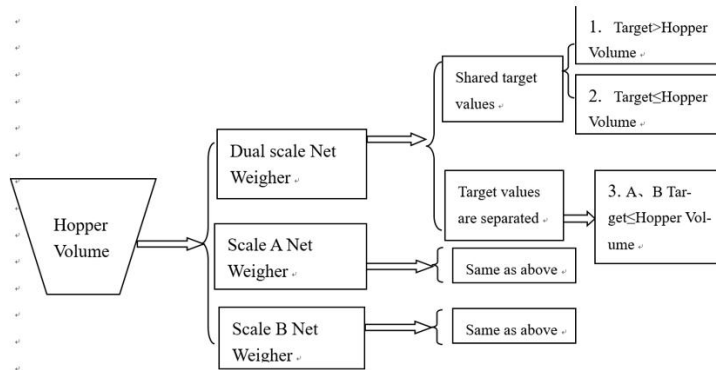

Process Description:

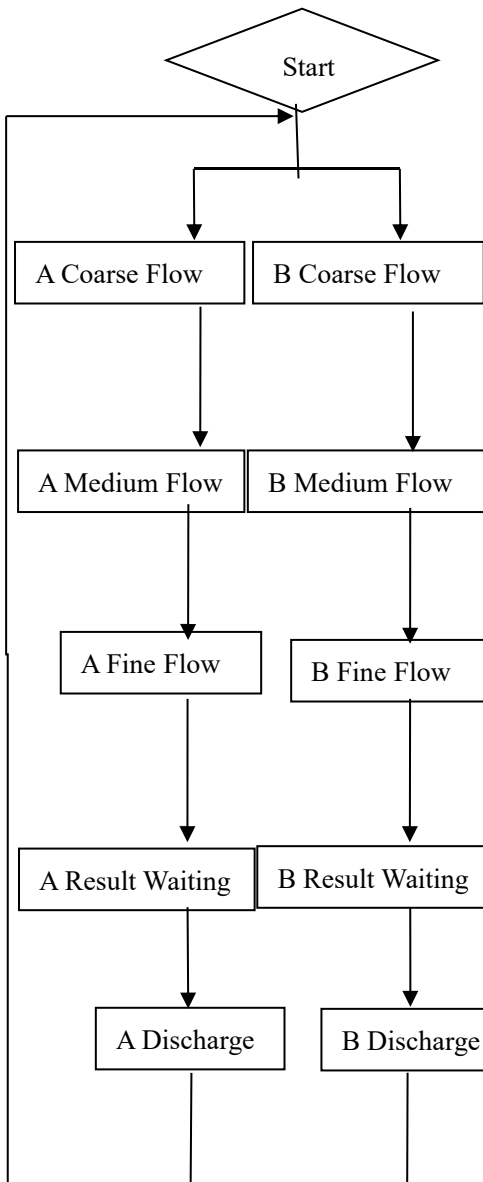

1) Start "Filling Start Delay"; 2) zero operation is determined (Auto Zero Interval)

1) Start "A/B COMP Inhibit Timer (Co-F)", no determination for the weight;

2) Analyzing Weight: The weight of the material \geq single scale target -A / B amount touching scale fast, Co-F closed, Me-F open.

1) Start "A/B COMP Inhibit Timer (Me-F)", no determination for the weight ;

2) Analyzing Weight: The weight of the material \geq single scale target -A / B amount touching scale fast, Me-F closed, Fi-F open.

1) Start "A/B COMP Inhibit Timer (Fi-F)", no determination for the weight ;

2) Analyzing Weight: The weight of the material \geq single scale target -A / B scale Free Fall, Fi-F closed, wait open.

1) Two result checking mode: Stability and delay determination (operating parameter selected), the end of the process according to the selected setting mode, from clutch bag to discharge.

1) Analyzing Weight: Material < Near Zero Band; 2) start "discharge delay." 3) To determine the final balance, then enter a "unlock bag" process or a "Filling Start Delay" under start.

※In stop state, the external "start up" input signal is valid, the scale starts to detect whether the set target value and the volume of a single hopper. If set to complete the work properly, otherwise it will prompt "target weight unreasonable" message, not start.

※ *Over/Under Judgment:*

When the "OVER/UNDER ON/OFF" turn on, in a packaging process, upon completion of the last weighing process, system will detecting over/under testing , .when the weight is stable, it will output over/under alarm signal.

When over/under is "ON", if this occurs the packaging tolerance over or under, the scale will automatically pause quantitative process, the buzzer sounds, the pop-up window displays the error message "A / B over/under pause" alarm information, the processing waits for the user, then press "enter" key or ON/OFF input "Clear alarm" effectively remove the alarm signal, said alarm clears scale and continue. User can also enter the emergency stop signal back to the stop state.

※*Unlock bags:*

Controller judge the last scale, "discharge delay" time after closing the discharge at the same time start "unlock bags start delay", after the delay to take the bag if completed will unlock bag if the bag is not completed will wait to unlock bags upon completion of pat bags.

In operation, if stop input is valid, when the scale completes the operation it will unlock bag return to stop state.

7.2 Scale A Net Weigher mode packing

Weigher structure choose with weighing Hopper, the mode selection parameter for the scale body is single scale Net Weigher A, since the method is applicable to the case of a mechanical failure or other reasons can only work for a scale.

1) Weigher structure choose with weighing Hopper, the mode selection parameter for the scale body is single scale Net Weigher A, AB individually set to off target, target value is set $\text{Target} > \text{Hopper Volume}$, if the target value is volume of a single hopper integral multiple of "the number of discharge calculated automatically" as a target value / volume of a single hopper. Otherwise, "the number of discharge calculated automatically" as a target value / single hopper volume +1, and the single hopper target is target value / unloading times automatically calculated. Only the scale A work alone, a total of unloading "discharge automatically calculates the number of" unlock bag only once.

2) Weigher structure choose with weighing hopper, the mode selection parameter for the scale body is scale Net Weigher A, AB individually set to off target, single target value

is set equal to less than the hopper volume, then the "number of discharge automatically calculated" is 1, single hopper target is target value. Only scale A work separately at this time, discharge material once and lock the bag once, scale B does not work.

3) Weigher structure choose with weighing hopper, the mode selection parameter for the scale body is scale A Net Weigher, AB individually set to on target, but can not exceed the volume of hopper, single hopper can not exceed volume; do not set target value at this time, even if you set is meaningless. Scale A completes the quantitative process according to target value A, discharge material once and lock the bag once, scale B does not work.

7.3 Scale B Net Weigher mode packing

Weigher structure choose with weighing hopper, the mode selection parameter for the scale body is single scale Net Weigher B, since the method is applicable to the case of a mechanical failure or other reasons can only work for a scale.

1) Weigher structure choose with weighing hopper, the mode selection parameter for the scale body is single scale Net Weigher B, AB individually set to off target, target value is set $\text{Target} > \text{Hopper Volume}$, if the target value is volume of a single hopper integral multiple of "the number of discharge calculated automatically" as a target value / volume of a single hopper. Otherwise, "the number of discharge calculated automatically" as a target value / single hopper volume +1, and the single hopper target is target value / unloading times automatically calculated. Only the scale B work alone, a total of unloading "discharge automatically calculates the number of" unlock bag only once.

2) Weigher structure choose with weighing hopper, the mode selection parameter for the scale body is scale Net Weigher B, AB individually set to off target, single target value is set equal to less than the hopper volume, then the "number of discharge automatically calculated" is 1, single hopper target is target value. Only scale B work separately at this time, discharge material once and lock the bag once, scale A does not work.

3) Weigher structure choose with weighing hopper, the mode selection parameter for the scale body is scale B Net Weigher, AB individually set to on target, but can not exceed the volume of hopper, single hopper can not exceed volume; do not set target value at this time, even if you set is meaningless. Scale B completes the quantitative process according to target value B, discharge material once and lock the bag once, scale A does not work.

Structure is shown below:

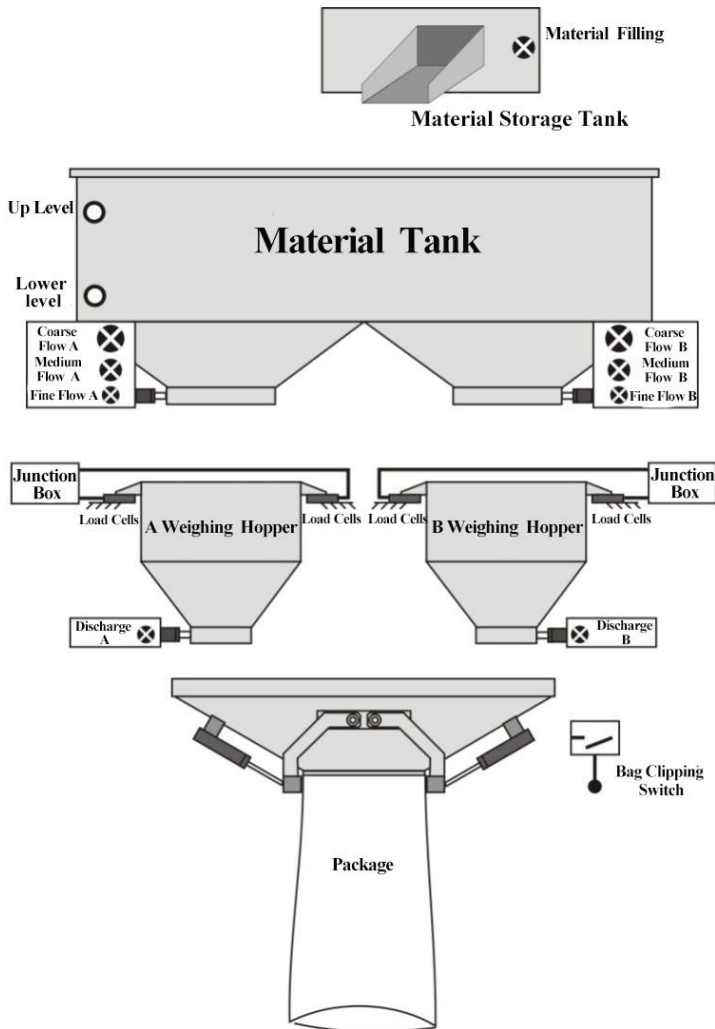

7.4 Dual hopper dual clampe bag AB separate packing mode

The structure of the weighing body is equipped with Net Weigher mode, and the working mode of the parameters of the weighing body is dual hopper dual clip bag AB separate.

1) Weighing body structure should be equipped with Net Weigher bagging, and the operation mode of the weighing body parameters should be dual hopper dual clip bag AB separate, and the target value of AB should be set as close separately. The target value should be greater than the maximum capacity of a single hopper. If the target value is an integer multiple of the maximum capacity of a single hopper, the "automatically calculated discharge times" should be the target value/maximum capacity of a single hopper. Otherwise, "automatically calculated discharge times" is the target value/the maximum capacity of a single hopper + 1, and the single weighing target value is the target value/the automatically calculated discharge times. At this time, A, B scales work separately, A total of discharge

"automatically calculated discharge times" only loose the bag once.

2) Weighing body structure should be equipped with Net Weigher bagging. The operation mode of the weighing body parameters should be dual hopper dual clip bag AB separate, and the target value of AB should be set as close separately. If the target value is set to be less than or equal to the maximum capacity of the single hopper, then the "number of discharging calculated automatically" is 1, and the target value of the single scale should be the target value. At this time only A, B scale independent work, discharge A loose bag once.

3) Weighing body structure should be equipped with Net Weigher bagging. The working mode of the parameters of the weighing body should be dual hopper dual clip bag AB separate, and the target value of AB should be set as open separately. The target value of A and B should be set separately, but not exceed the maximum capacity of single hopper, and the maximum capacity of single hopper should not exceed the maximum range. Do not set the target value at this time, even if set also useless. The A scale completes the quantitative process according to the target value of A, discharge the material once and loosening the bag once, while the B scale completes the quantitative process according to the target value of B, discharge the material once and loosening the bag once.

After starting, if A has finished discharge, controller will start the conveyor to start conveying. The same is B scales.

7.5 Dual hopper dual clip bag AB Comb packing mode

The structure of the weighing body is equipped with Net Weigher mode, and the working mode of the parameters of the weighing body is dual hopper dual clip bag AB comb.

1) Weighing body structure should be equipped with Net Weigher bagging, and the operation mode of the weighing body parameters should be dual hopper dual clip bag AB comb, and the target value of AB should be set as close separately. The target value should be greater than the maximum capacity of a single hopper. If the target value is an integer multiple of the maximum capacity of a single hopper, the "automatically calculated discharge times" should be the target value/maximum capacity of a single hopper. Otherwise, "automatically calculated discharge times" is the target value/the maximum capacity of a single hopper +1, and the single weighing target value is the target value/the automatically calculated discharge times. At this time, A, B scales work separately, A total of discharge "automatically calculated discharge times" only loose the bag once.

2) Weighing body structure should be equipped with Net Weigher bagging. The operation mode of the weighing body parameters should be dual hopper dual clip bag AB comb, and the target value of AB should be set as close separately. If the target value is set to be less than or equal to the maximum capacity of the single hopper, then the "number of discharging calculated automatically" is 1, and the target value of the single scale should be

the target value. At this time only A, B scale work separately, discharge and loose bag once.

3) Weighing body structure should be equipped with Net Weigher bagging. The working mode of the parameters of the weighing body should be dual hopper dual clip bag AB comb, and the target value of AB should be set as open separately. The target value of A and B should be set separately, but not exceed the maximum capacity of single hopper, and the maximum capacity of single hopper should not exceed the maximum range. Do not set the target value at this time, even if set also useless. The A scale completes the quantitative process according to the target value of A, discharge the material once and loosening the bag once, while the B scale completes the quantitative process according to the target value of B, discharge the material once and loosening the bag once.

After starting, B scale began to filling materials, A scale also began to filling materials, and wait for A and B are loose bags, controller control conveyor started, the packaging bag filling finished will be transported, and then clip the bag to start the next process.

Note: Dual Net Weigher bagging adopts two hoppers, two clip bag mechanisms, and the work of AB scale (work of the conveyor, other work will not affect each other).

Structure is shown in the following figure:

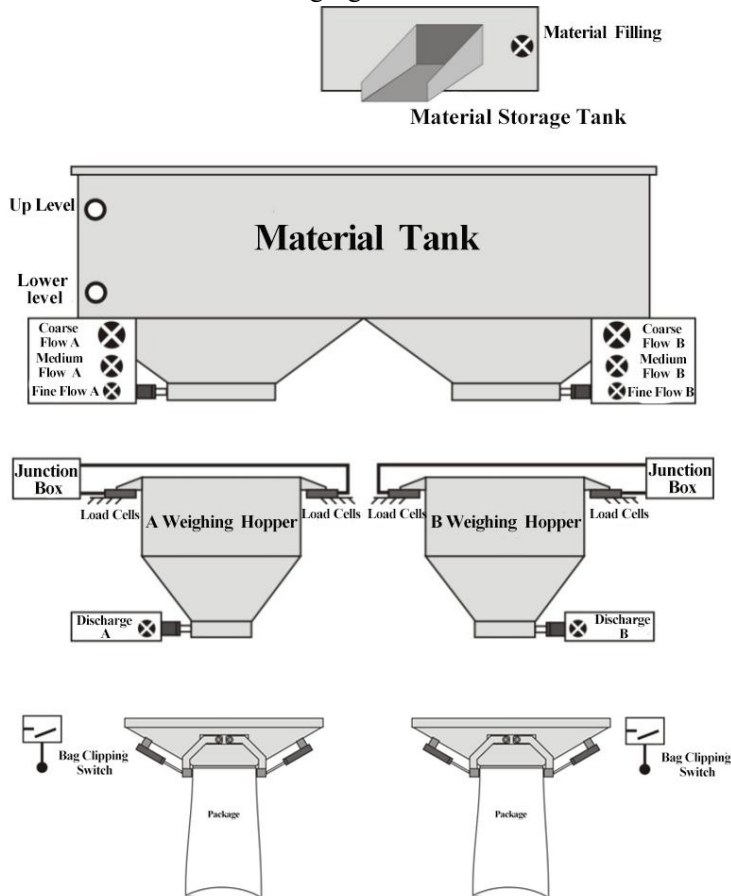

7.6 Dual scale Gross Weigher mode packing

Gross Weigher mode, material from the material tank through the filling mechanism filling directly to the bag (coarse, medium, fine flow), controlling weight metering process sampling is complete (processing load cells mounted on the hopper) in a packaging bag. After the completion of metering, controller controls to unlock bag. The difference between Gross Weigher packing and Net Weigher packing process is that the sensor is mounted on the hopper. After starting, after complete lock bag operation, it starts filling delay process.

Weigher structure choose Gross Weigher packaging, the mode selection parameter choose AB Comb Gross Weigher. 1) If AB target value is set to Off separately, the target value is the target value of A and B scale; 2) If AB target value is set to On separately, the target values of A and B are respectively the targets of A and B. All are independent of the volume, but can not exceed the volume.

After starting, scale B bag begins to fill, scale A bag begins to fill, and waits for the A and B unlock bags, controller control conveyor started, transport the finished packaging bag, start the next process.

If the bag filling of A is completed and the bag is loosened, and the bag is not clip in B, controller controls the conveyor to start; If the bag is not clip in the scale A, the bag filling is completed and the bag is loosened in the scale B, and controller controls the conveyor to start.

7.7 Dual scale Gross Weigher individual packing

Weigher structure choose Gross Weigher bagging, the mode selection parameter choose AB Separate Gross Weigher. 1) If AB target value is set to Off separately, the target value is the target value of A and B scales; 2) If AB target value is set to On separately, the target values of A and B are respectively the targets of A and B. All are independent of the volume, but can not exceed the volume.

After start, any scale finish filling then unlock bag, controller will start transporting conveyor.

Structure is shown below:

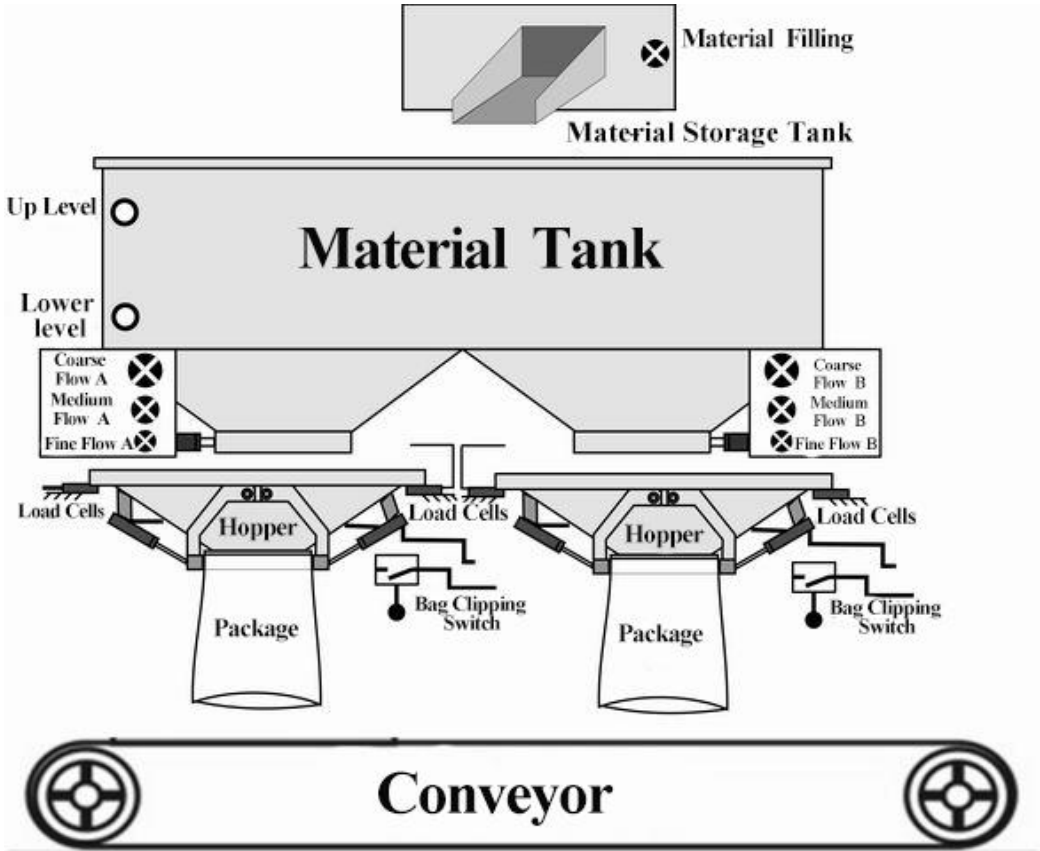

7.8 Bulk accumulation process

1) Bulk scale AB Interlock: Under the operating state, scale A start to add the material to the weighing tank (coarse, medium and fine), and the weight sampling of the controlling control process is completed in the weighing tank (the weighing load cell is mounted on the weighing tank). After the controlling is completed, the material is discharged through the unloading mechanism on the weighing tank and the weight value is accumulated. When scale A is discharging, scale B starts feeding and carry out the weighing. The weighing units of A and B are interlocked for loading/unloading.

2) Bulk scale AB independent: The two scales can be fed and discharged at the same time, without interlocking.

3) Bulk single hopper A: Only scale A works.

4) Bulk single hopper B: Only scale B works.
works.

Basic process description:

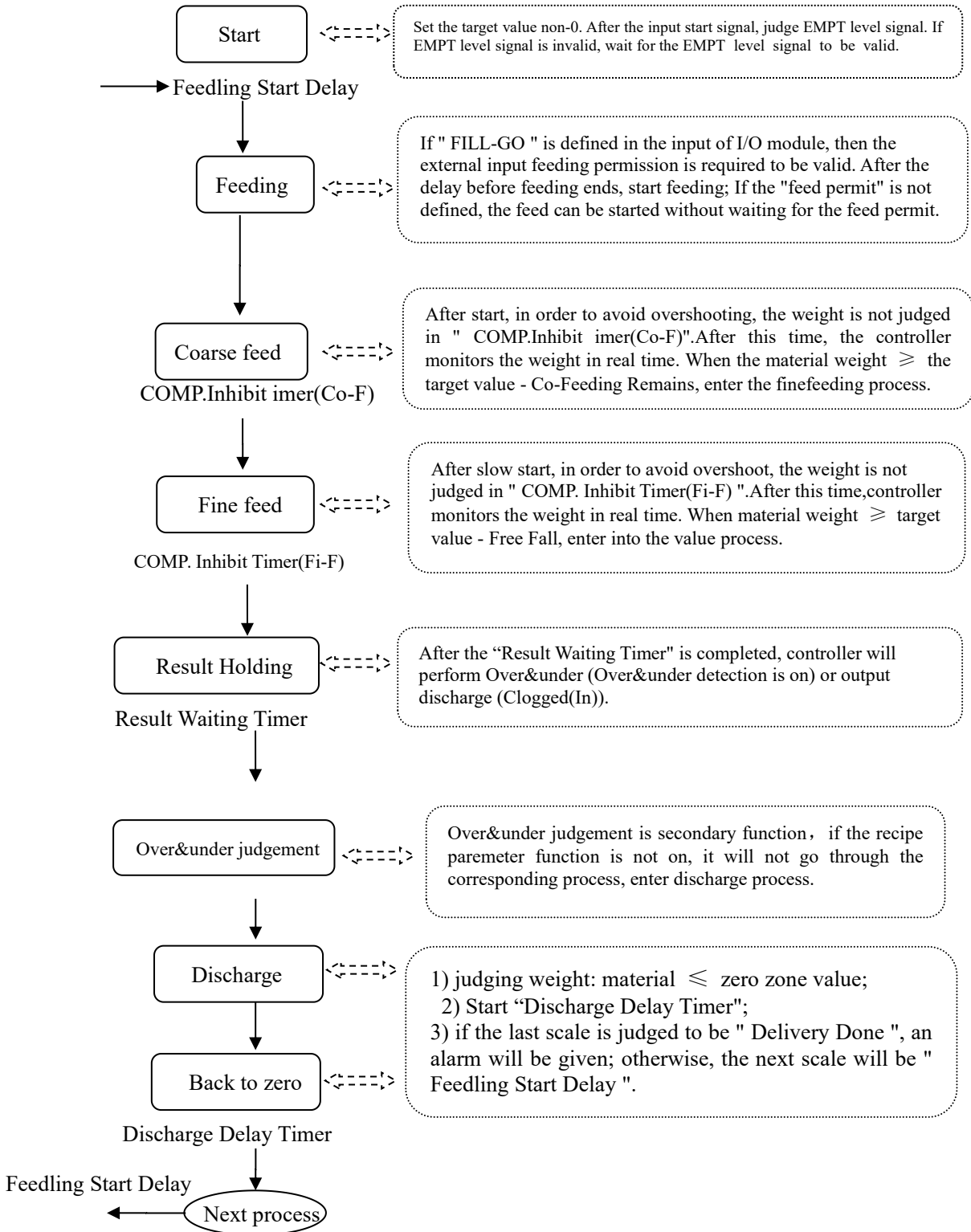

8. Motor Work Process

8.1 Motor Filling Portion

8.1.1 Step Motor Drive Filling

Step motor drive control filling door ON/OFF: I/O Module involved are: **O31 (A Filling O/P PU) / O32 (A: Filling O/P DR) / O33 (B Filling O/P PU) / O34 (B Filling O/P DR), I31 (A Filler Gate Closed)/ I32 (B Filler Gate Closed). (I31 / I32-The signal is determined by the type of signal in place).**

Take scale A Coarse flow, Medium flow, Fine flow for example:

- Coarse flow process: controller control O32 (motor rotational direction signal) to ensure the gate opening direction to the direction of motor rotation, then O31 (A Filling O/P PU) according to the A: filler motor frequency output pulse to control the stepping motor rotate to the gate opening direction, O31 (A Filling O/P PU) stop the output pulse after the number reaches the set value, the filler gate stops rotating, this is coarse flow state. Then controller Change O32 (motor rotational direction signal) output as closing gate direction.
- Medium flow process: O31 (A Filling O/P PU) according to the A:filler motor frequency output pulse to control the stepping motor rotate to the gate closing direction, O31 (A Filling O/P PU) stop the output pulse after the number reaches the set value, the filler gate stops rotating, this is medium flow state.
- Fine flow process: O31 (A Filling O/P PU) according to the A:filler motor frequency output pulse to control the stepping motor continuing rotate to the gate closing direction, O31 (A Filling O/P PU) stop the output pulse after the number reaches the set value, the filler gate stops rotating, this is fine flow state.
- Filling closing: O31 (A Filling O/P PU) according to the A:filler motor frequency output pulse to control the stepping motor continuing rotate to the gate closing direction, until detecting I31 (A:Filler Gate Closed) value input, then it stop output pulse signal, the filler gate stops rotating, filling is completely closed.

8.1.2 Motor Drive Filling

Motor drive mode control filler gate ON/OFF: I/O Module involved are: scale A **O43 (A filler open) / O45 (A filler open), I31 (A: Filler Gate Closed), scale B O44 (B filler open) / O46 (B filler close), I32 (B: Filler Gate Closed).**

Take scale A Coarse flow, Medium flow, Fine flow for example:

- Coarse flow process: scale A begins filling after a delay time t1. Controller first controls scale A **O43 (A filler open)** signal output valid, the effective time is **A: Co-F, Gate Open Time**, start coarse flow process.

- Medium flow process: weight of the material in the scale $A \geq$ single scale target value-scale A coarse flow remains, scale A **O45(A filler open)** signal output is valid, the valid time is "scale A Coarse flow Gate Open Time – scale A Medium Flow Gate Open Time "
- Fine flow process: weight of the material in the scale $A \geq$ single scale target value-scale A medium flow remains, A **O45(A filler open)** signal output is valid, the valid time is "scale A Medium Flow Gate Open Time – scale A Fine Flow Gate Open Time "
- Flow off: weight of the material in the scale $A \geq$ single scale target value-scale A fine flow remains, scale A **O45(A filler open)** signal output is valid, until detecting **A filler gate limit signal I31 (A:Filler Gate Closed)**.
- note:in case closing process is longer than the filler gate close overtime, controller has not yet detected I31 (A loading door closed in place),Then the controller will stop O45 (A closed fill),and alarm scale A filler gate close overtime.

Note: When controller started, it is necessary to detect whether filler gate and discharge gate are in the limit, if not, controller will alarm and can't be started.

8.2 Motor lock Bag Portion

8.2.1 Step Motor Drive lock/unlock bag

Step motor drive controls bag lock/unlock: I/O Module involved are: **O35 (A: Bag Clutch O/P PU) / O36 (A: Bag Clutch O/P DR) / O37 (B: Bag Clutch O/P PU) / O38 (B: Bag Clutch O/P DR), I33 (A: Bag Released)/ I34 (B: Bag Released)**. (I37/I38 signal is determined by the limited signal type.)

Take binyES with metering hopper mode, bag lock/unlock process for sample:

- Lock bag process: controller control **O36 (A: Bag Clutch O/P DR)** output, ensure motor rotating direction is lock bag direction, then **O35 (A: Bag Clutch O/P PU)** according to the **A clutch motor frequency** to output pulse, control lock/unlock step motor rotating to lock bag direction, **O35 (A:Bag Clutch O/P PU)** number reach setted **scale A clutch pulse number** it will stop output pulse signal, at this time lock/unlock mode is in the lock bag state. Then controller change **O36 (A: Bag Clutch O/P DR)** output to unlock direction.
- Unlock bag process: **O35 (A:Bag Clutch O/P PU)** according to the setted **scale A clutch motor frequency** to output pulse, control unlock step motor rotating to unlock direction, until detecting **I33(A:Bag Released)** input valid then stop output pulse signals, this is unlock state. Note: if unlock bag process time more than **Bag Release Overtime**, controller has not yet detected **I33 (A: Bag**

Released), then the controller will stop output **O35 (A: Bag Clutch O/P PU)**, and alarm **scale A: Bag Unlock overtime**.

8.2.2 Motor Drive Dual-Limit lock/unlock bag

Motor drive dual-limit controls bag lock/unlock: I/O Module involved: **O9 (A lock bag) / O47 (A unlock bag) / O12 (B lock bag) / O48 (B unlock bag), I23 (A Bag Locked) / I33 (A Bag Released) / I24 (B Bag Locked) / I34 (B Bag Released)**. (I33/I34 signal is determined by the Limit signal type).

Take binyES with metering hopper mode, bags lock/unlock process for sample:

- Lock bag process: controller output lock bag signal (O9 A lock bag) to control Clutch bag motor rotating to lock bag direction, until detecting bag locked signal (I23 A Bag Locked) input valid then stop output lock bag signal (O9 A lock bag), at this time lock bag mode is in the lock state. Note: in case lock bag process time exceeds the setted **Bag Lock Overtime**, controller has not yet detected bag locked signal (I23 A Bag Locked), then controller stop output lock bag signal (O9 A lock bag), and alarm **A Bag Lock Overtime**.
- Unlock bag process: controller output unlock bag signal(O47 A unlock bag) to control Clutch bag motor rotating to unlock bag direction, until detecting Clutch Limit Signal Type (I33 A Bag Released)input valid then stop output unlock bag signal(O47 A unlock bag), at this time lock/unlock mode is in the unlock state. Note: in case unlock bag process time exceeds the setted **Bag Release Overtime**, controller has not detected bag released signal (I33 A Bag Released), then controller stop output unlock bag signal (O47 A unlock bag), and alarm **scale A Bag Release Overtime**.

8.2.3 Motor Drive Single-Limit lock/unlock bag

Motor drive dual-limit controls lock/unlock bags: I/O Module involved: **O9 (A lock bag) / O47 (A unlock bag) / O12 (B lock bag) / O48 (B unlock bag), I23 (A Bag Locked) / I24 (B Bag Locked)**

Take binyES with metering hopper mode, bags lock/unlock process for sample:

- Lock bag process: controller control O9 (**A lock bag**) I/O module output signals, output signal until detecting bag locked signal I23 (Bag Locked) input is valid, this output signal output is invalid, lock bag.
- Unlock bag process: controller control O47 (**A unlock bag**) I/O module output signals, in order to unlock bag, output signal time of duration is for unlock bag output, this output signal is invalid.

Note: in case lock bag time of duration exceeds setted **Bag Lock Overtime**, controller has not detected A Bag Locked I23 (**A Bag Locked**), then controller will stop output O9 (**A lock bag**), and alarm **scale A Bag Lock Overtime**.

8.3 Motor Discharge Portion

8.3.1 Step Motor Drive Discharge

Step motor control discharge: I/O Module involved are: **I25 (A DISC gate closed) scale A O39 (A: DISC O/P PU), O40 (A: DISC O/P DR).**

Take scale A discharge for sample:

- Discharge gate opening process: controller control **O40 (A: DISC O/P DR)** output, to ensure that the motor rotating direction is gate opening direction, then **O39 (A: DISC O/P PU)** according to the set **Discharge Gate Opened Motor Frequency** output pulse, to control the discharge step motor rotating to discharge opening gate direction, **O39 (A: DISC O/P PU)** number reaches setted **A discharge pulse needed number's** value then stop output pulse signals, at this time discharge mode is in the open state.
- Discharge gate closing process: after the discharge gate opened, if controller detecting hopper weight lower than **Near Zero Value**, then start the **Discharge Delay Time**, when the discharge delay time is finish, controller change **O40 (A: DISC O/P DR)** as the closing direction, **O39 (A: DISC O/P PU)** according to the setted **Discharge Gate Opened Motor Frequency** to output pulse, to control the discharge step motor rotating to closing gate direction, until detecting **I25 (A DISC gate closed)** input value then stop output pulse signals, at this time is closing gate state. Note: in case closing process time exceeds setted **DISC Gate Close Overtime**, controller has not yet detecting closing gate signal **I25 (A DISC gate closed)**, then controller will stop output **O39 (A: DISC O/P PU)**, and alarm **scale A discharge gate close overtime**.

8.3.2 Motor Drive Single-Limit Discharge

Motor positive and negative rotation single-limit mode control discharge: I/O Module involved are: **O11 (A Discharge) O14 (B Discharge) O49 (A DISC Gate Close) O50 (B DISC Gate Close), I25 (A DISC Gate Closed)/ I26 (B DISC Gate Closed).**

Take scale A discharge process for sample:

- Discharge gate open process: when discharge process begin, controller output discharge signal **O11 (A Discharge)** to control discharging motor rotating to discharge gate open direction, and continue setting **scale A discharge gate open output valid time** setted discharge motor open gate signal output time, then close discharge signal **O11 (A Discharge)** output.
 - Discharge gate close process: after the discharge gate open, if controller detecting hopper weight lower than **Near Zero Value**, then start the **Discharge Delay Time**, when the discharge delay time is finish, it output discharge gate

close signals **O49 (A DISC Gate Close)** to control discharge motor rotating to discharge gate closing direction, until detecting discharge gate close signal **I25 (A DISC Gate Closed)** input valid then stop output discharge gate close signal **O49 (A DISC Gate Close)**, at this time discharge gate is closed. **Note:** in case discharge gate close process time exceed setted **A Discharge gate close overtime**, controller has not yet detecting discharge gate close signal **I25 (A DISC Gate Closed)**, then controller will stop output **O49 (A DISC Gate Close)**, and alarm scale **A discharge gate close overtime**.

8.3.3 Motor Drive Dual-Limit Discharge

Motor positive and negative rotation dual-limit mode control discharge: I/O Module involved are: **O11 (A Discharge) / O14 (B Discharge) / O49 (A DISC Gate Close) / O50 (B DISC Gate Close), I25 (A DISC Gate Closed)/ I35 (A DISC Gate Opemd) /I26 (B DISC Gate Closed) / I36 (B DISC Gate Opemd)**.

Take scale A discharge process for sample:

- Discharge gate open process: when discharge process begin, controller output discharge signal **O11 (A Discharge)** to control discharging motor rotating to discharge gate open direction, until detecting DISC Gate Open **I35 (A DISC Gate Opemd)** input valid then stop output discharge signal **O11 (A Discharge)**, at this time discharge gate is open state. **Note:** in case discharge gate open process time exceeds the setted **A discharge gate open overtime**, controller has not yet detected DISC Gate Open **I35 (A DISC Gate Opemd)**, then controller stop output **O11 (A Discharge)**, and alarm scale **A discharge gate open overtime**.
- Discharge gate close process: After the discharge gate open, if controller detecting hopper weight lower than **Near Zero Value**, then start the Discharge Delay Time, when the discharge delay time is finish, controller output discharge gate close signal **O11 (A Discharge)**, to control the discharge motor rotating to close gate direction, until detecting DISC Gate Close **I25 (A DISC Gate Closed)** input value then stop output discharge gate close signal **O11 (A Discharge)**, at this time is discharge gate close state. **Note:** in case discharge gate close process time exceeds setted **A discharge gate close overtime**, controller has not yet detecting DISC Gate Close signal **I25 (A DISC Gate Closed)**, then controller will stop output **O11 (A Discharge)**, and alarm **A discharge gate close overtime**.

8.3.4 Motor Drive Rotating Discharge

Motor drive rotating discharge control discharge: I/O Module involved are: **O11 (A Discharge) / O14 (B Discharge), I25 (A DISC Gate Closed)/ I26 (B DISC Gate Closed)**.

Take scale A discharge process for sample:

- Discharge gate open process: when discharge process begin, controller output discharge signal **O11 (A Discharge)** to control discharging motor rotating to discharge gate open direction, and continue setting **discharge motor gate open signals output time**, then close discharge signal **O11 (A Discharge)** output.
- Discharge the close process: After the discharge gate open, if controller detecting hopper weight lower than **Near Zero Value**, then start the Discharge Delay Time, when the discharge delay time is finish, controller output discharge signal **O11 (A Discharge)**, to control the discharge motor rotating to discharge gate close direction, until detecting DISC Gate Close **I25 (A DISC Gate Closed)** input value then stop output discharge signal **O11 (A Discharge)**, at this time is discharge gate close state.

Note: In case discharge gate close process time exceeds **discharge gate close over time**, controller has not yet detecting DISC Gate Close signal **I25 (A DISC Gate Closed)**, then controller will stop output **O11 (A Discharge)**, and alarm **scale A discharge gate close overtime**.

8.4 Motor Debug Function

Motor debug function is to facilitate user's quick determine the door size, coarse flow, medium flow, fine flow, take debug fine flow open gate for example:

Steps as follow:

- Step1: The left side of the interface is the current number of coarse, medium and fine pulses. You can modify the current pulse number of fine flow in the input box.
- Step2: Click "open fine flow" button to make the controller output fine flow signal. User determines whether the current pulse number is appropriate by checking the opening size of the filling door. (note: click "close fine flow" again to close fine flow. Controller can only be in one state, can not in the state of coarse flow and medium flow at the same time).
- Step3: If the pulse number has been modified, press the "save" button to save the modified pulse number. If do not want to save the modified pulse number, exit the motor debugging interface to restore the previous coarse, medium and fine pulse number.

9. Dimension (mm)

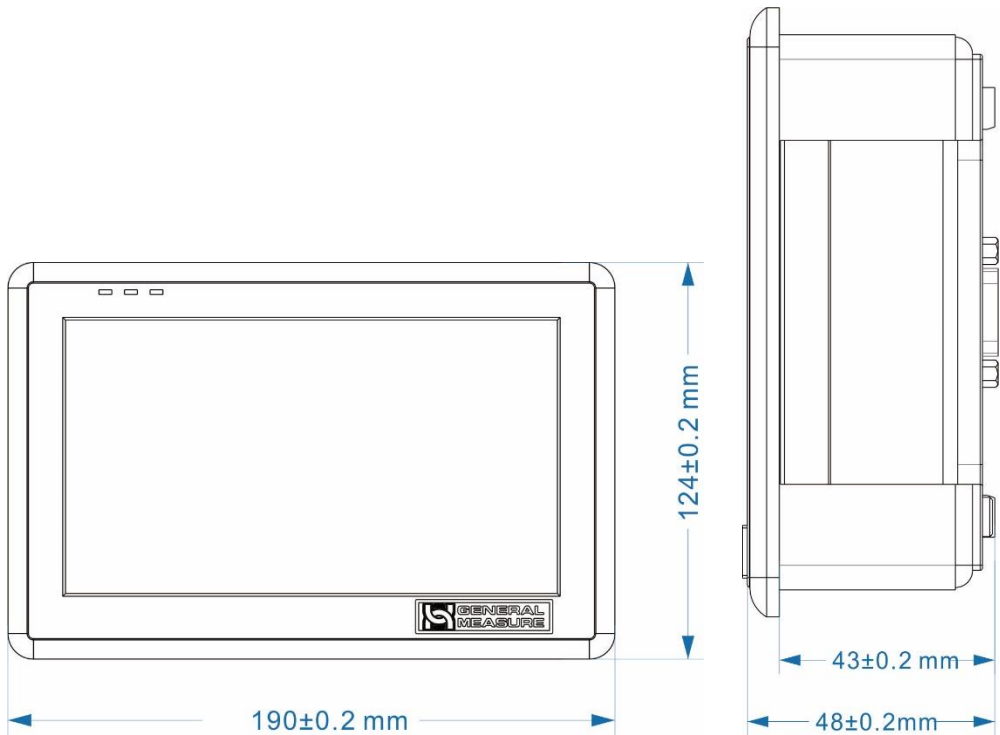

Mounting hole size

